

Vorderansicht

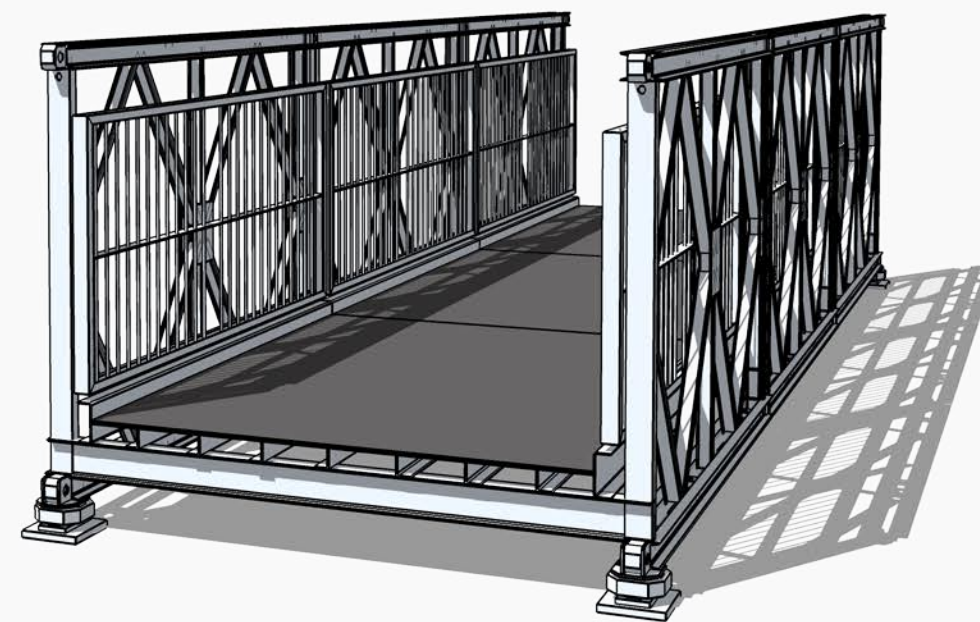

3D-Darstellung

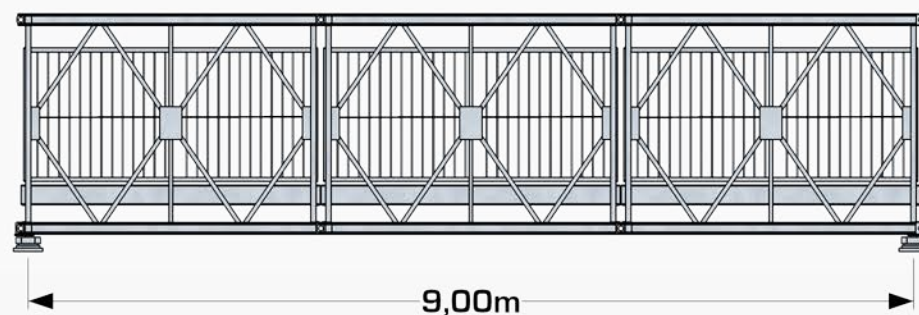

Seitenansicht

	2,00m	2,50m	3,00m
verfügbare Deckbreiten			3,00m
			6,00m
			9,00m
			12,00m
			15,00m
verfügbare Spannweiten			18,00m
			21,00m
			24,00m
			27,00m
			30,00m
			33,00m
			36,00m
			39,00m
			etc.
nachweisbar:	DIN-FB 101		
	DIN 1072		
	EuroCode		

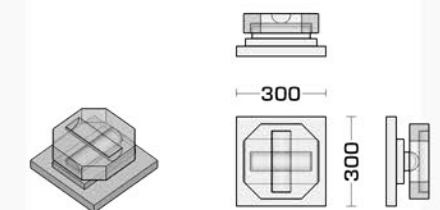

Detail: Lagerplatte

JPB ped - 12,00m x 2,50m SS

Fußgängerbrückensystem Typ JPB ped

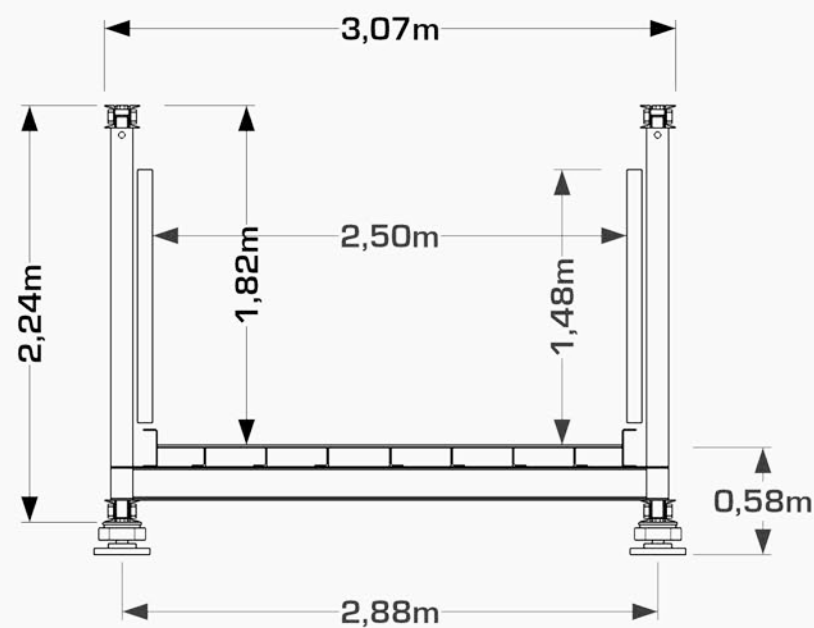

Vorderansicht

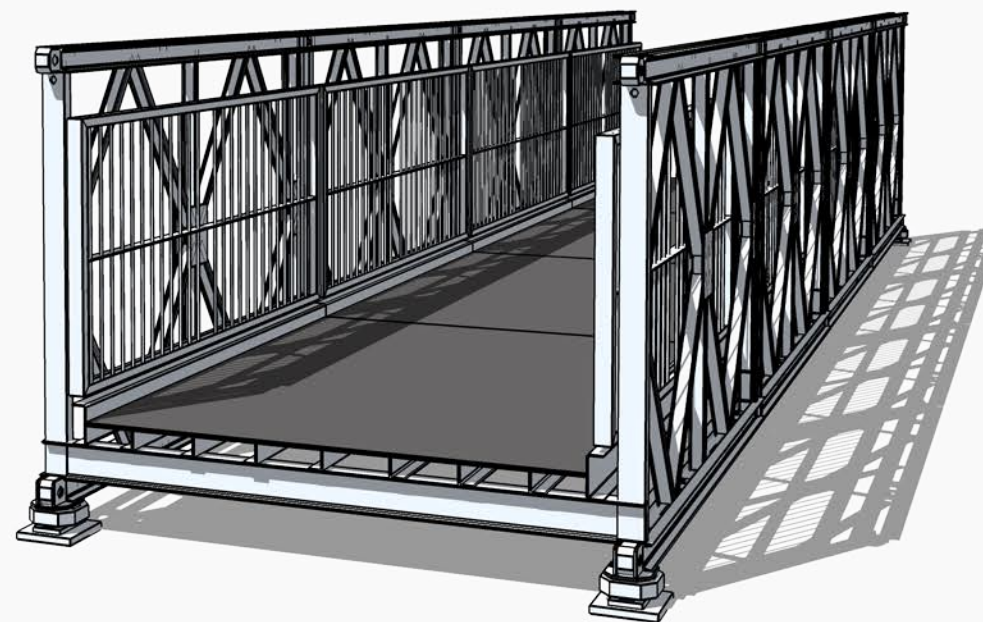

3D-Darstellung

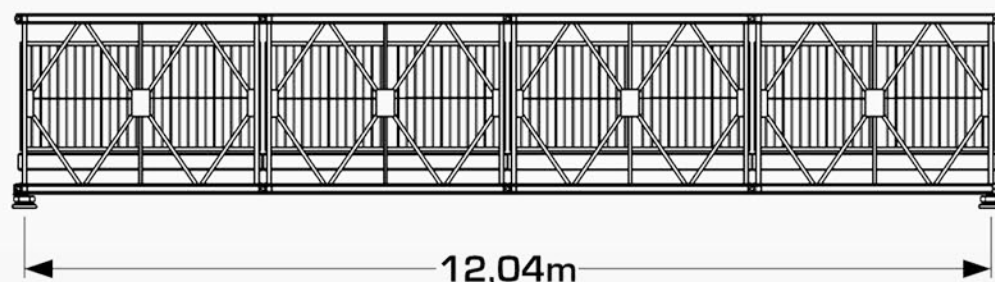

Seitenansicht

	2,00m	2,50m	3,00m
verfügbare Deckbreiten	2,00m, 2,50m und 3,00m		
verfügbare Spannweiten	3,00m bis 60,00m freispannend		
nachweisbar:	DIN-FB 101 DIN 1072 EuroCode		
			3,00m 6,00m 9,00m 12,00m 15,00m 18,00m 21,00m 24,00m 27,00m 30,00m 33,00m 36,00m 39,00m etc.

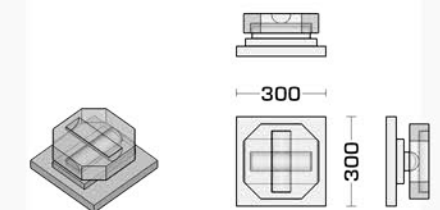

Detail: Lagerplatte

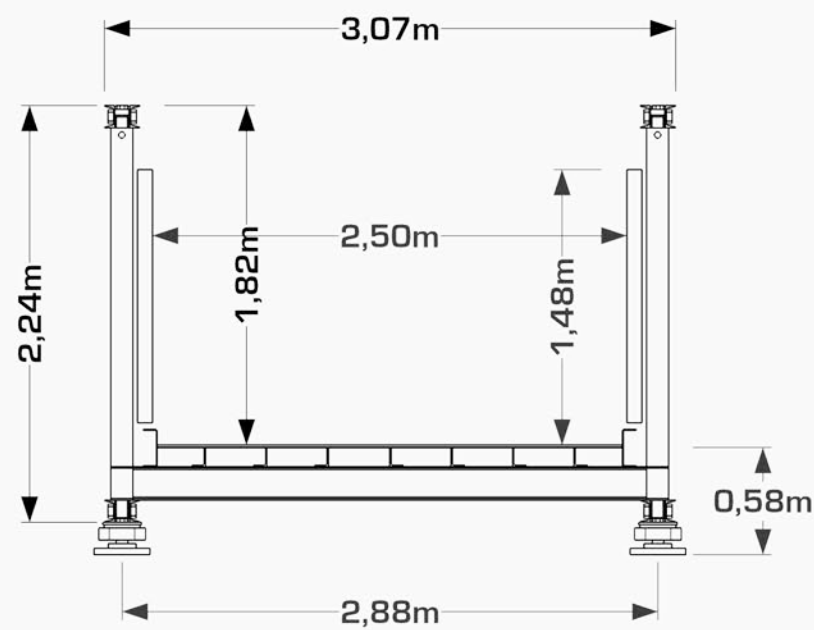

Vorderansicht

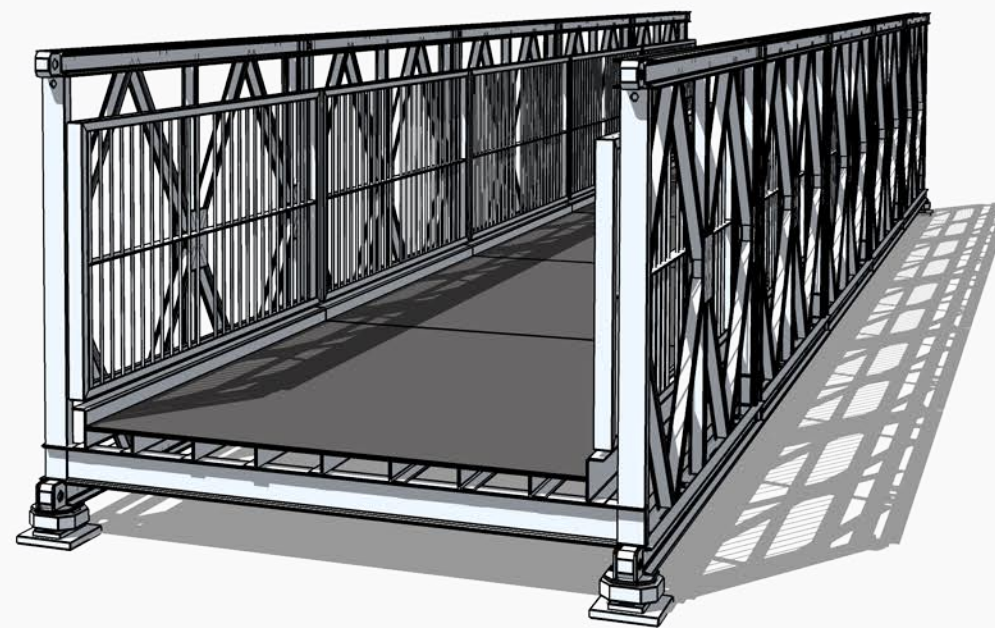

3D-Darstellung

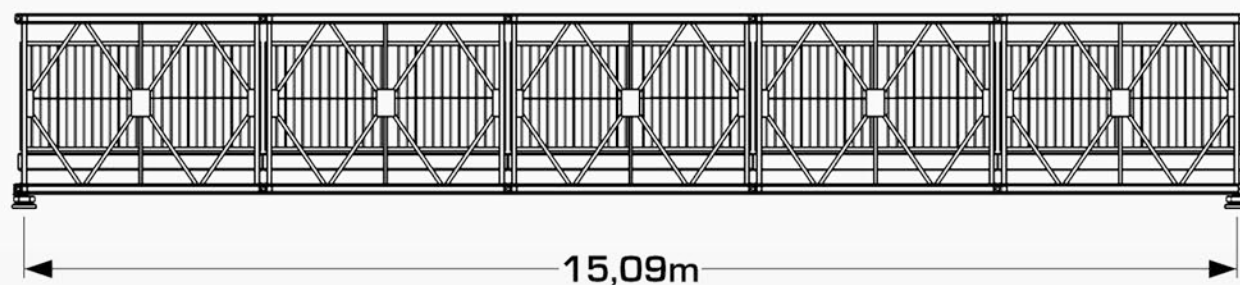

Seitenansicht

	2,00m	2,50m	3,00m
verfügbare Deckbreiten	2,00m, 2,50m und 3,00m		
verfügbare Spannweiten	3,00m bis 60,00m freispannend		
nachweisbar:	DIN-FB 101 DIN 1072 EuroCode		
			3,00m 6,00m 9,00m 12,00m 15,00m 18,00m 21,00m 24,00m 27,00m 30,00m 33,00m 36,00m 39,00m etc.

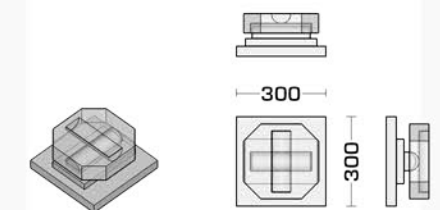

Detail: Lagerplatte

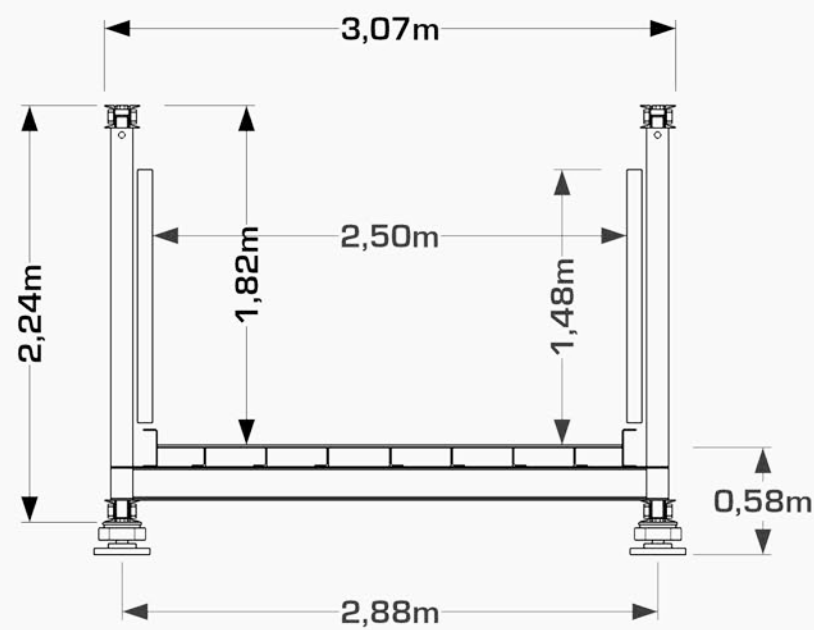

Vorderansicht

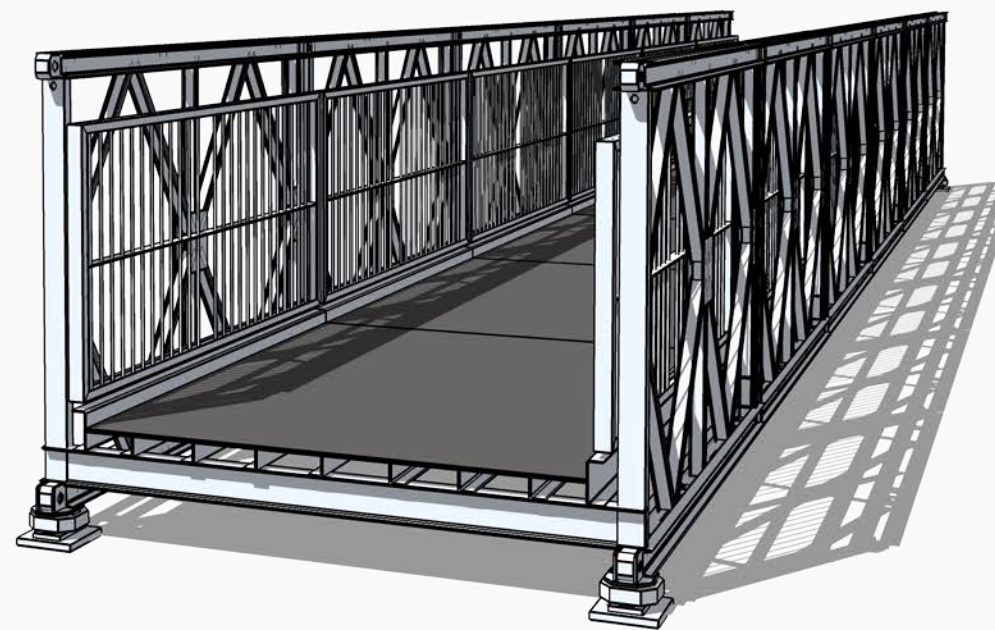

3D-Darstellung

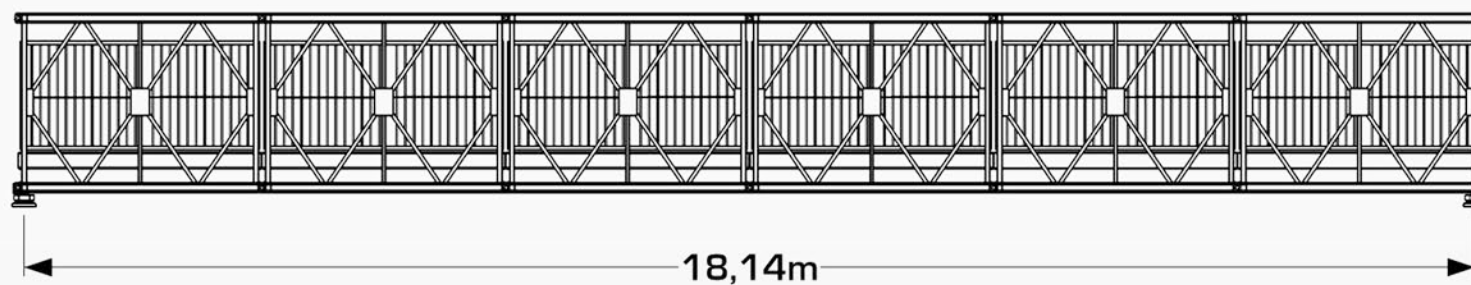

Seitenansicht

	2,00m	2,50m	3,00m
verfügbare Deckbreiten	2,00m, 2,50m und 3,00m		
verfügbare Spannweiten	3,00m bis 60,00m		
nachweisbar:	DIN-FB 101		
	DIN 1072		
	EuroCode		
			3,00m
			6,00m
			9,00m
			12,00m
			15,00m
			18,00m
			21,00m
			24,00m
			27,00m
			30,00m
			33,00m
			36,00m
			39,00m
			etc.

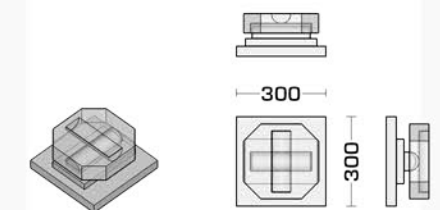

Detail: Lagerplatte

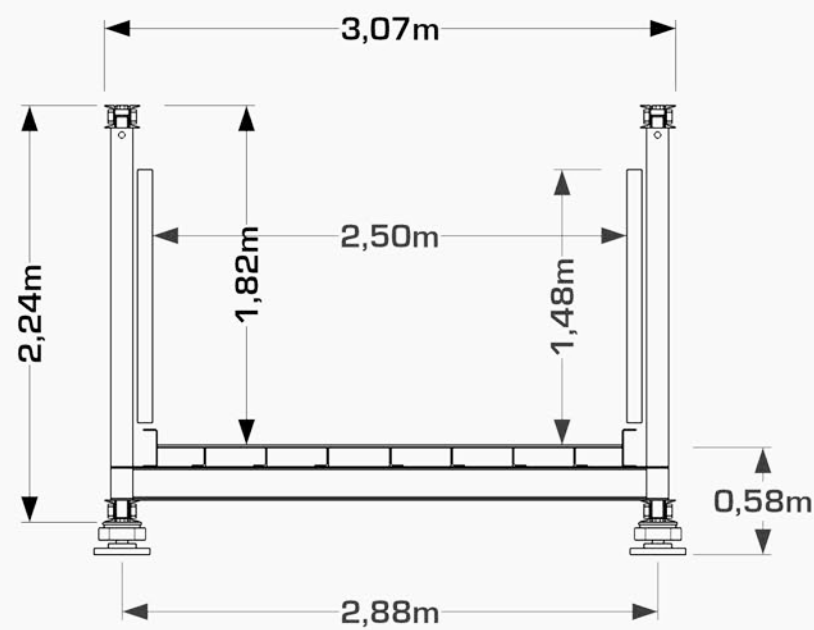

Vorderansicht

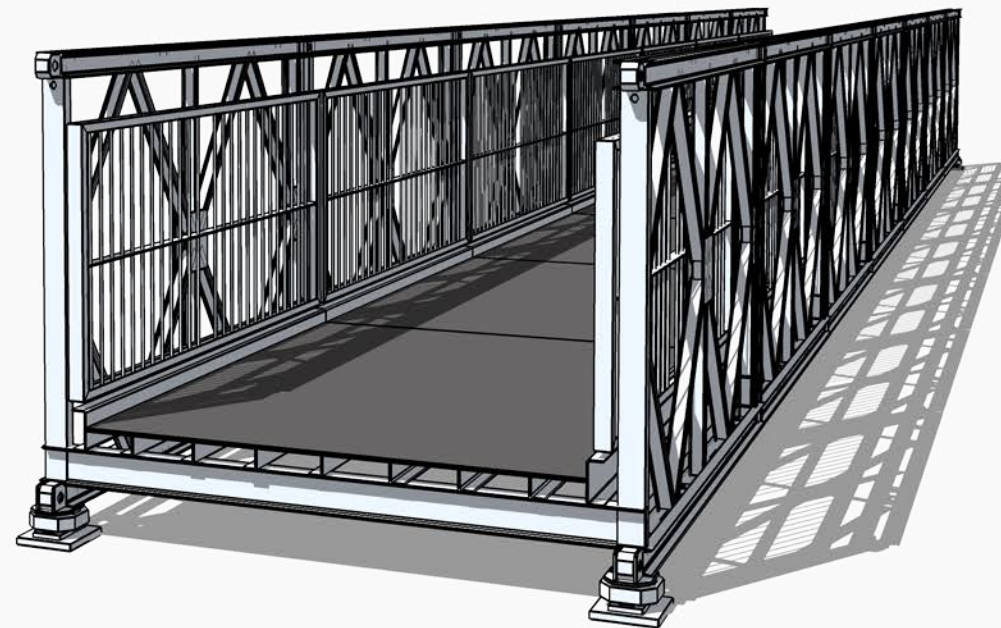

3D-Darstellung

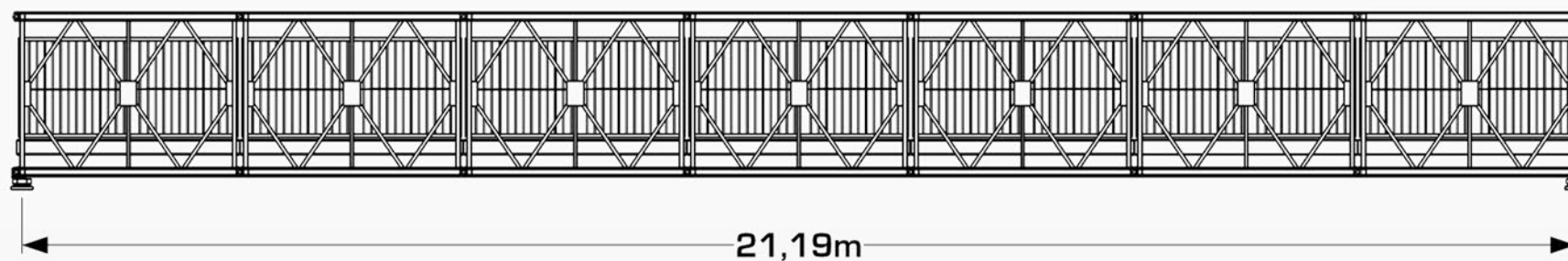

Seitenansicht

	2,00m	2,50m	3,00m
verfügbare Deckbreiten	2,00m, 2,50m und 3,00m		
verfügbare Spannweiten		3,00m bis 60,00m freispannend	
nachweisbar:	DIN-FB 101 DIN 1072 EuroCode		
			3,00m 6,00m 9,00m 12,00m 15,00m 18,00m 21,00m 24,00m 27,00m 30,00m 33,00m 36,00m 39,00m etc.

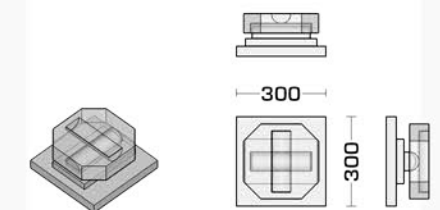

Detail: Lagerplatte

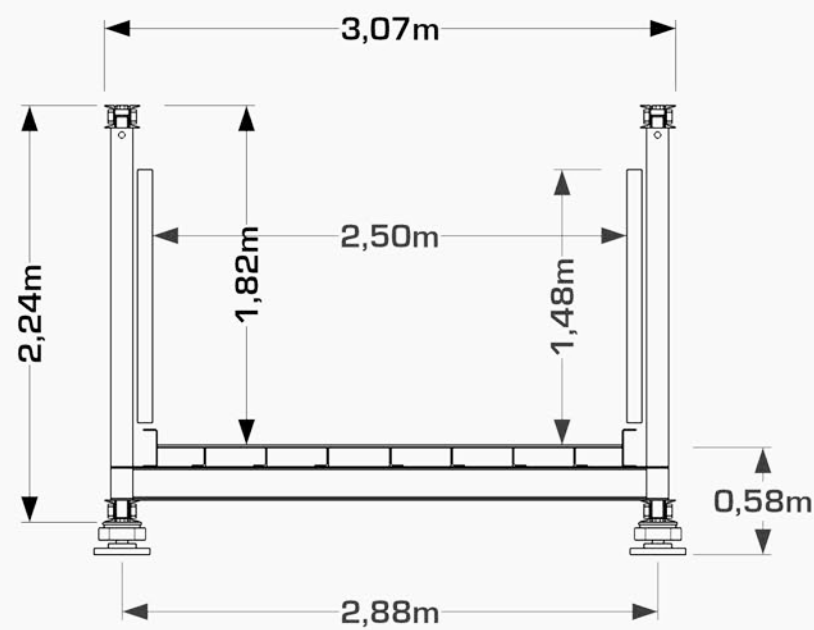

Vorderansicht

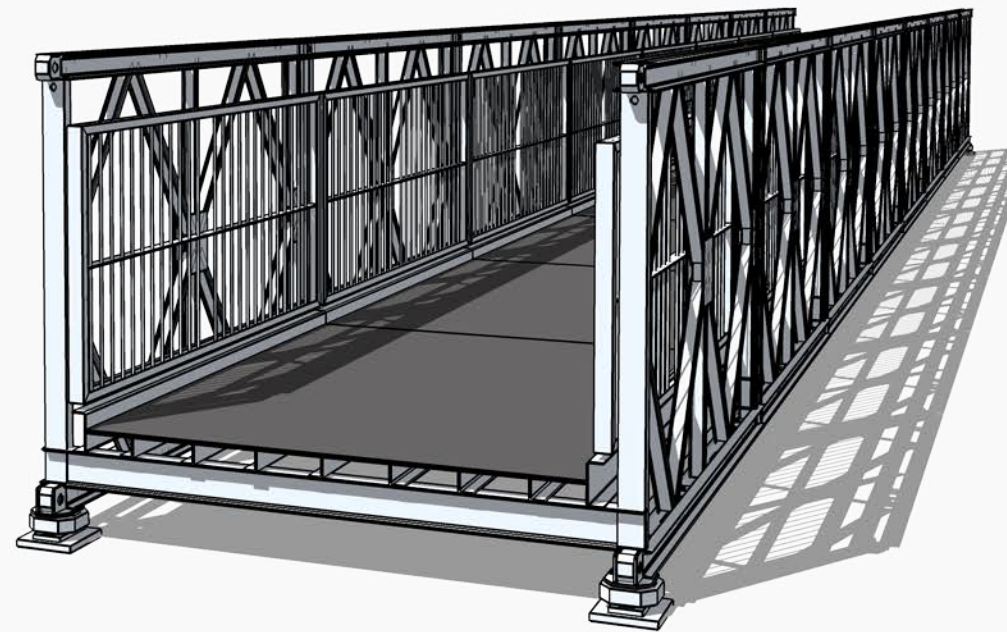

3D-Darstellung

	2,00m	2,50m	3,00m
verfügbare Deckbreiten			3,00m 6,00m 9,00m 12,00m 15,00m
verfügbare Spannweiten			18,00m 21,00m 24,00m 27,00m 30,00m 33,00m 36,00m 39,00m etc.
nachweisbar:	DIN-FB 101 DIN 1072 EuroCode		

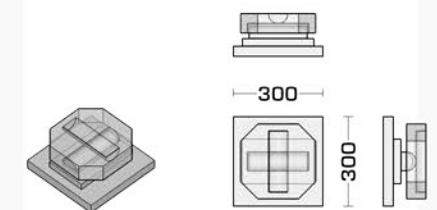

Detail: Lagerplatte

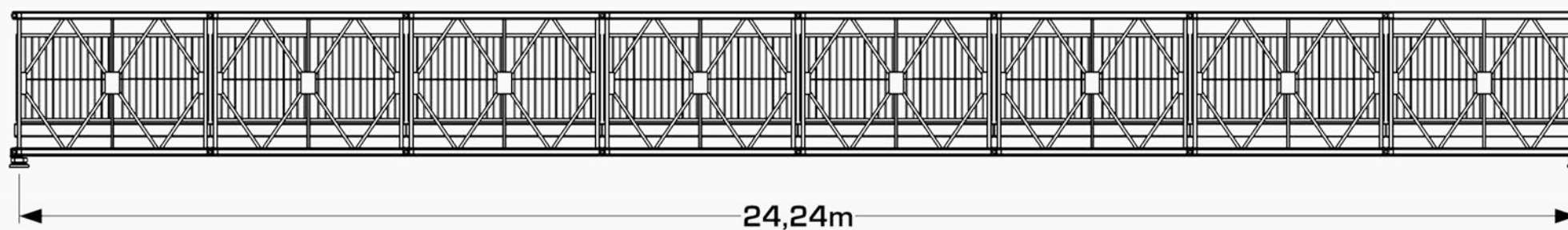

Seitenansicht

	2,00m	2,50m	3,00m
verfügbare Deckbreiten	2,00m, 2,50m und 3,00m		
verfügbare Spannweiten	3,00m bis 60,00m freispannend		
nachweisbar:	DIN-FB 101 DIN 1072 EuroCode		
			3,00m 6,00m 9,00m 12,00m 15,00m 18,00m 21,00m 24,00m 27,00m 30,00m 33,00m 36,00m 39,00m etc.

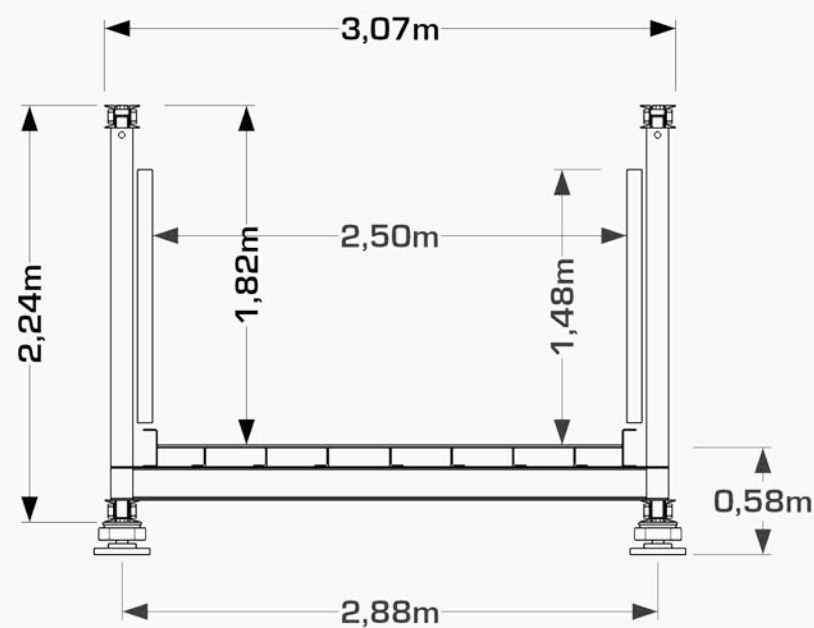

Vorderansicht

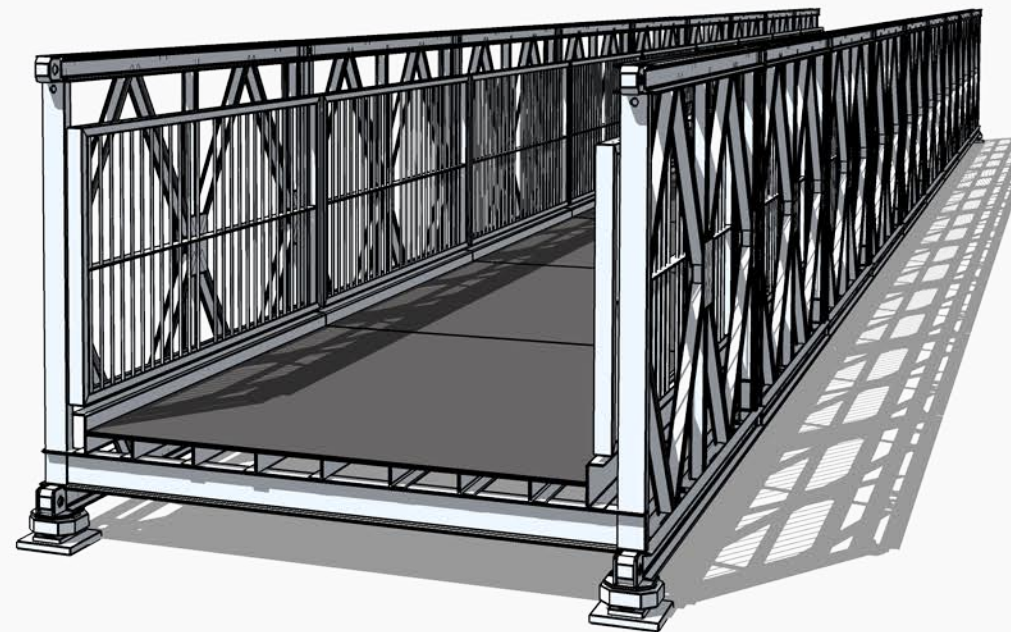

3D-Darstellung

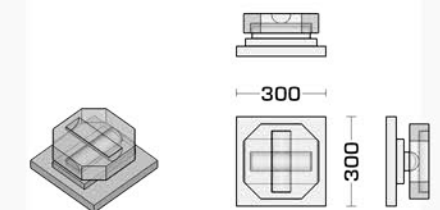

Detail: Lagerplatte

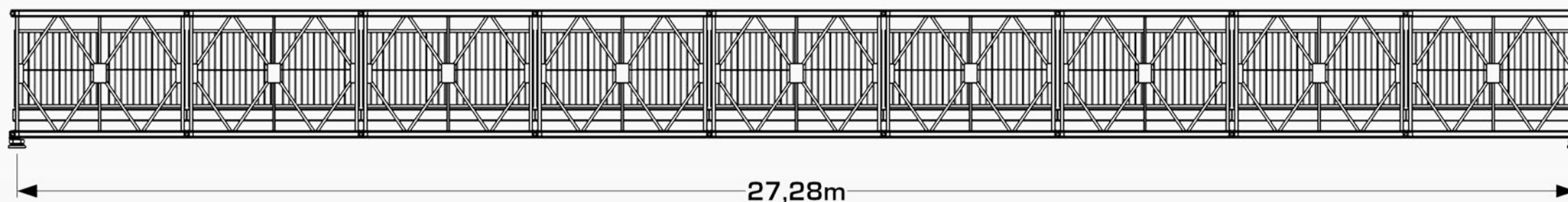

Seitenansicht

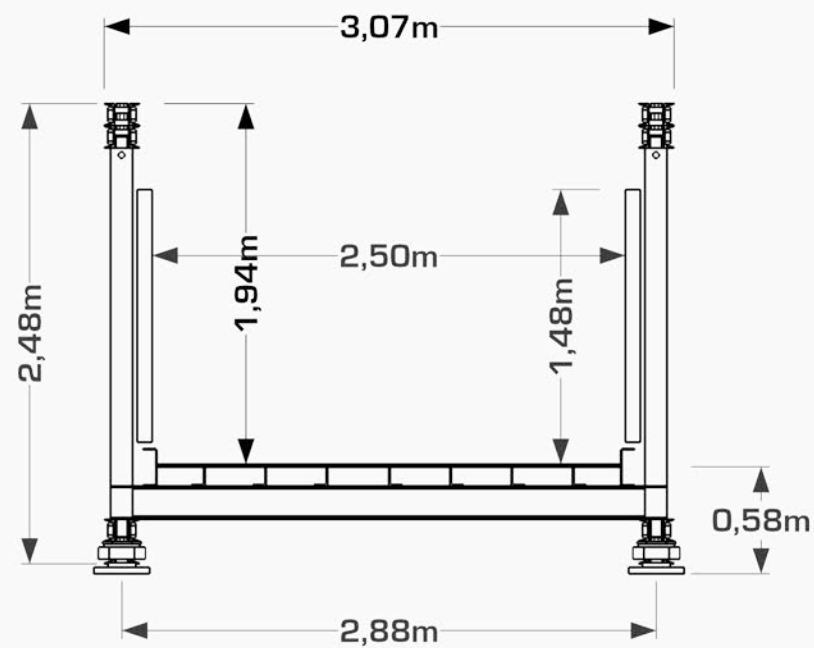

Vorderansicht

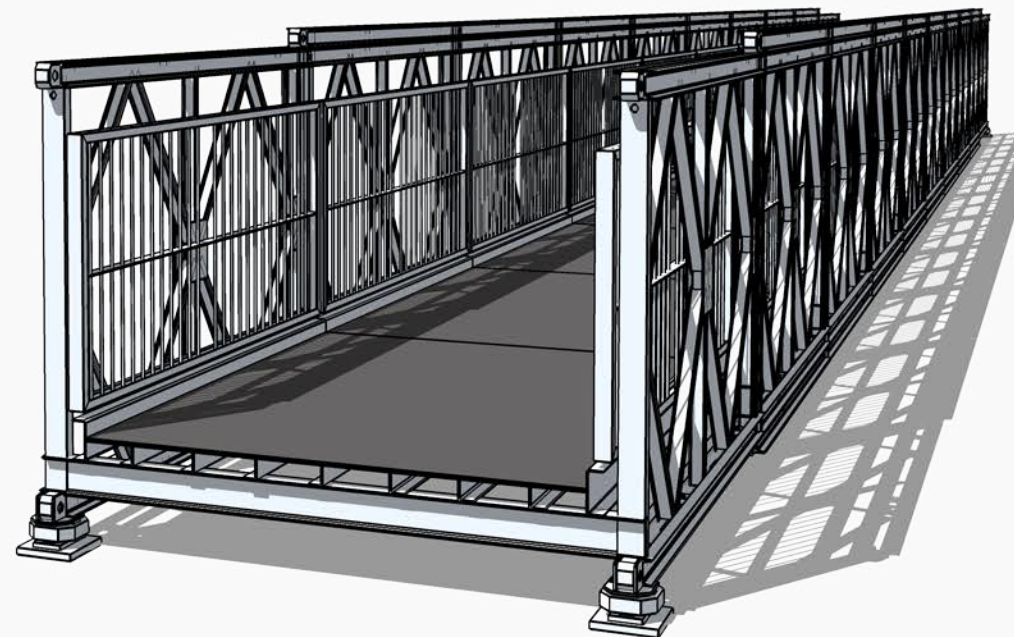

3D-Darstellung

	2,00m	2,50m	3,00m
verfügbare Deckbreiten			3,00m 6,00m 9,00m 12,00m 15,00m
verfügbare Spannweiten			18,00m 21,00m 24,00m 27,00m 30,00m 33,00m 36,00m 39,00m etc.
nachweisbar:	DIN-FB 101 DIN 1072 EuroCode		

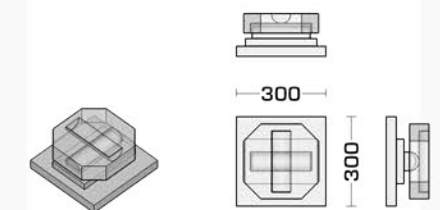

Detail: Lagerplatte

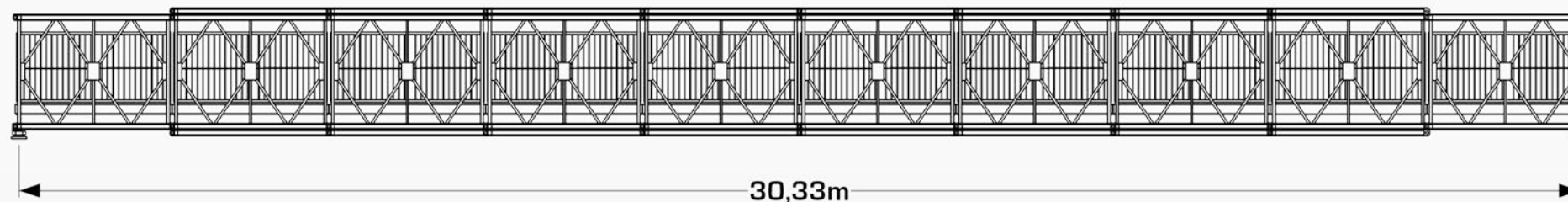

Seitenansicht

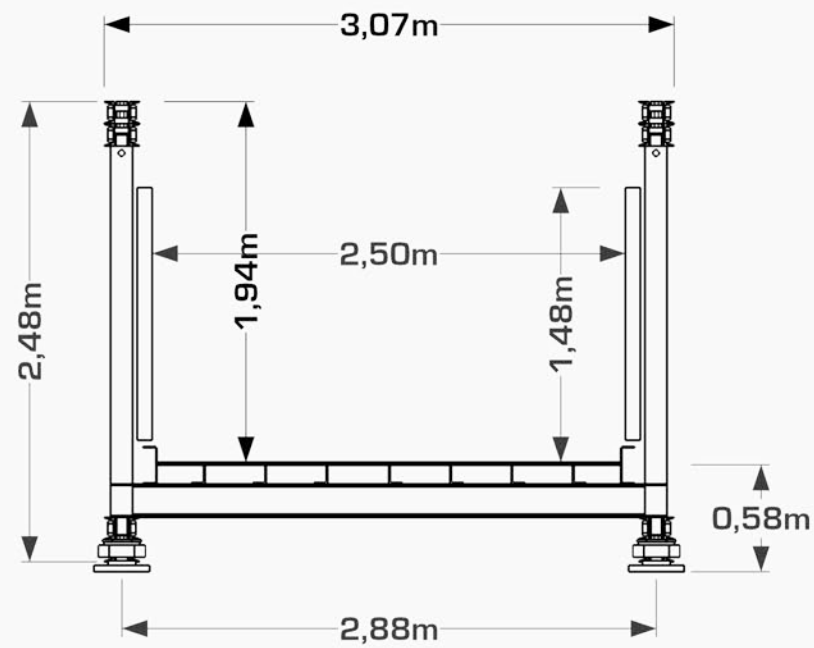

Vorderansicht

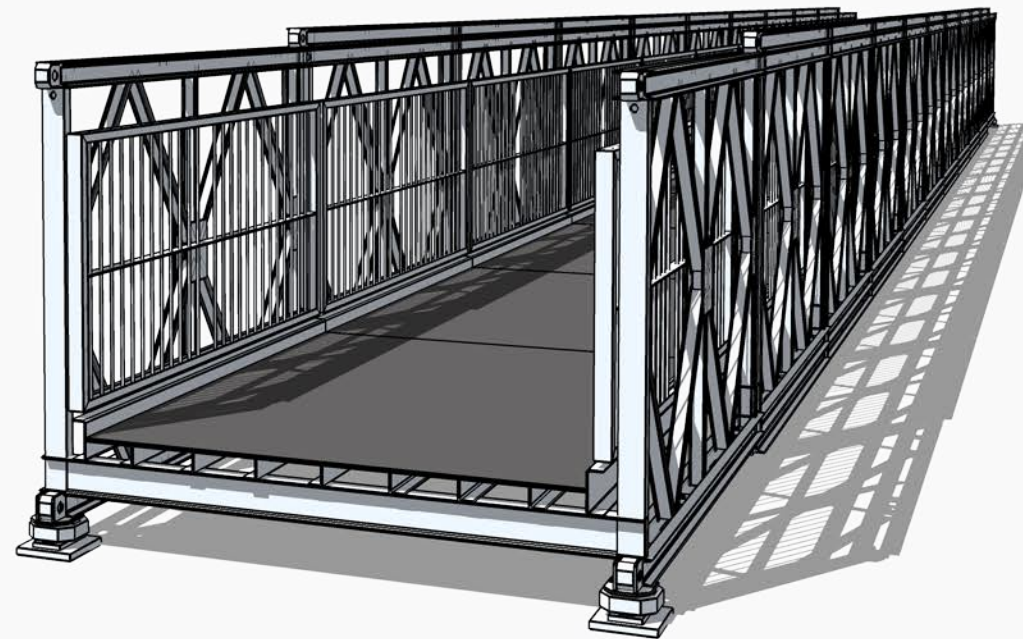

3D-Darstellung

	2,00m	2,50m	3,00m
verfügbare Deckbreiten			3,00m 6,00m 9,00m 12,00m 15,00m
verfügbare Spannweiten			18,00m 21,00m 24,00m 27,00m 30,00m
			33,00m 36,00m 39,00m etc.
nachweisbar:	DIN-FB 101 DIN 1072 EuroCode		

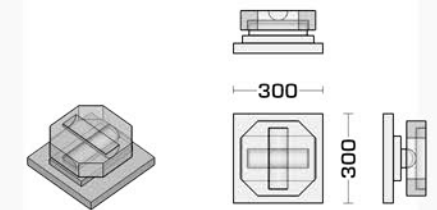

Detail: Lagerplatte

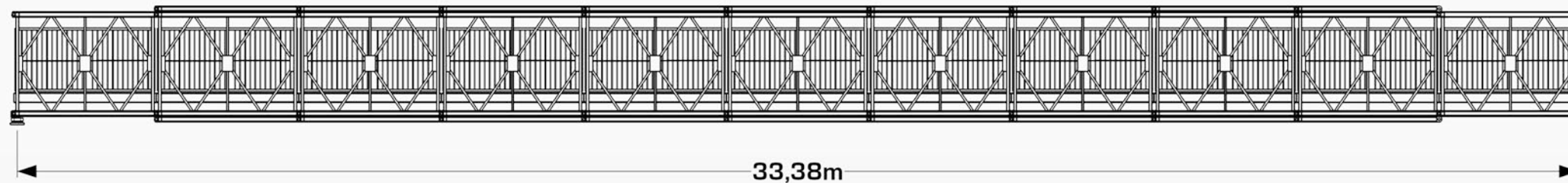

Seitenansicht

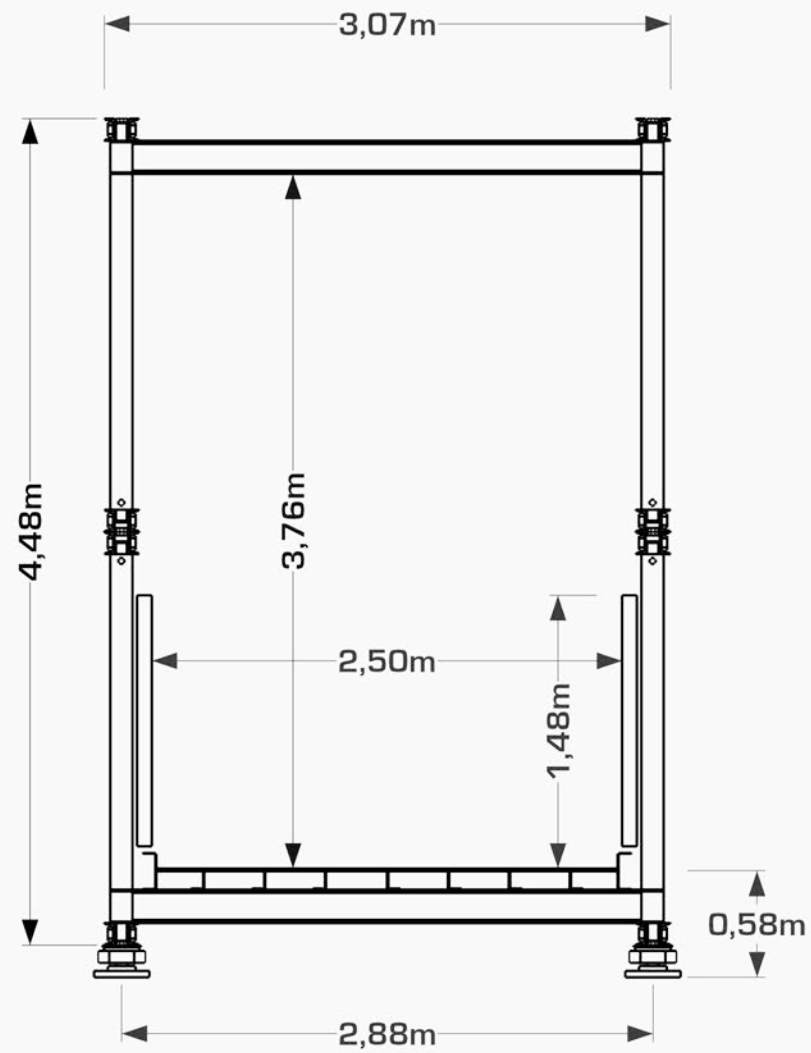

Vorderansicht

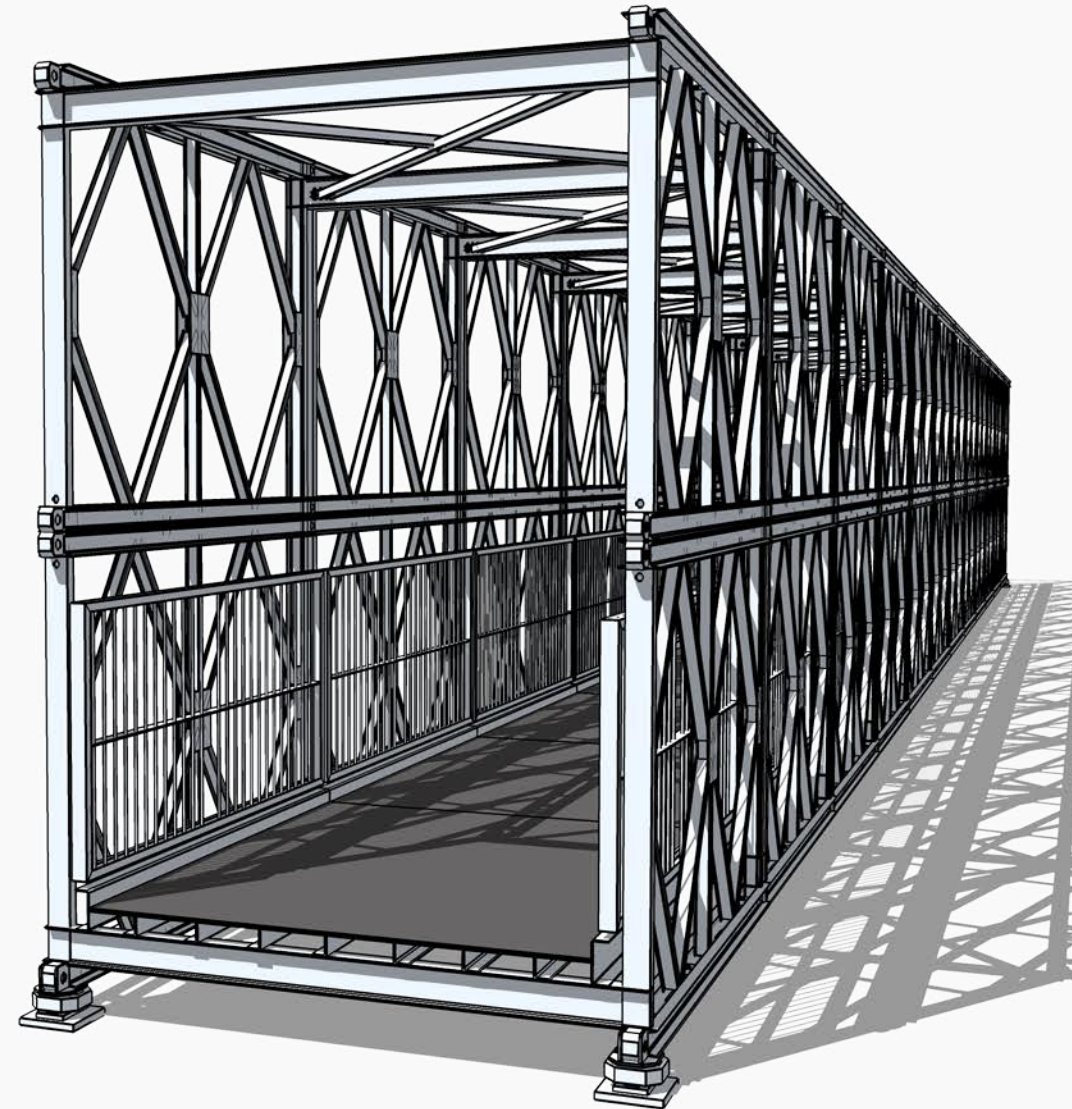

3D-Darstellung

	2,00m	2,50m	3,00m
verfügbare Deckbreiten			3,00m 6,00m 9,00m 12,00m 15,00m
verfügbare Spannweiten			18,00m 21,00m 24,00m 27,00m 30,00m 33,00m 36,00m 39,00m etc.
nachweisbar:	DIN-FB 101 DIN 1072 EuroCode		

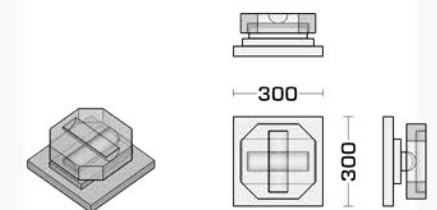

Detail: Lagerplatte

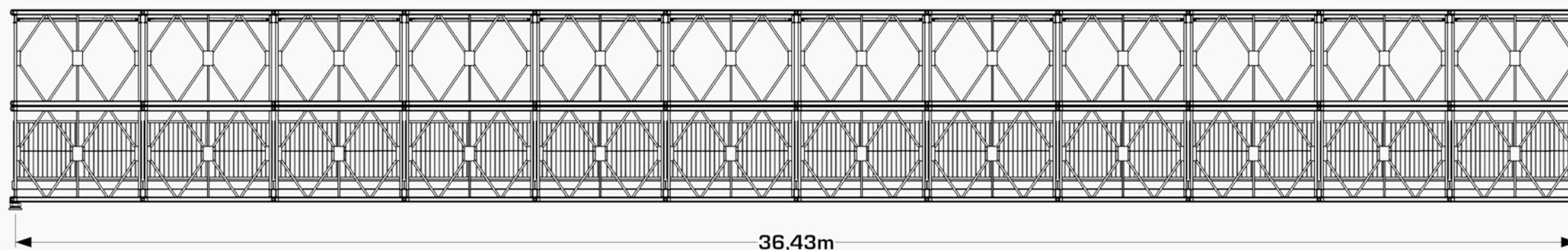

Seitenansicht

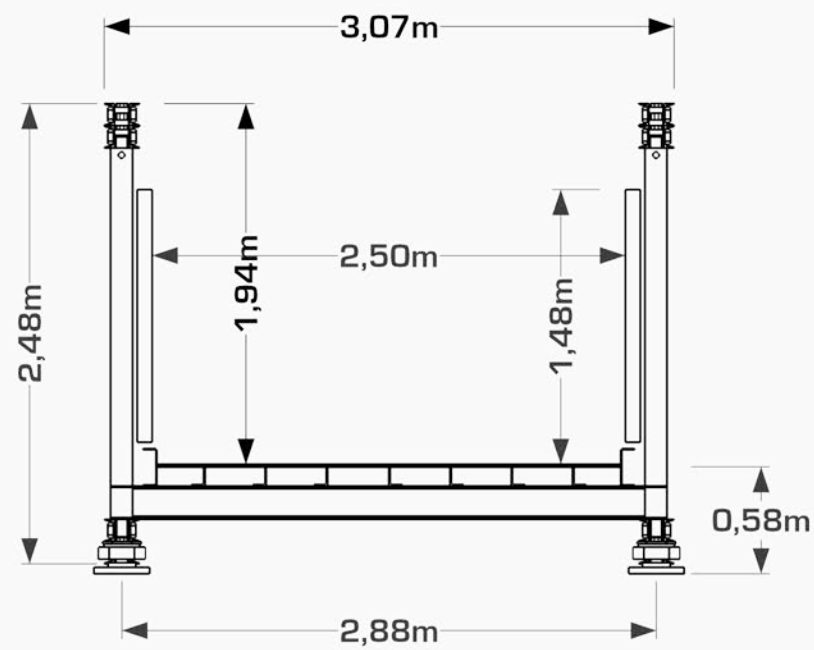

Vorderansicht

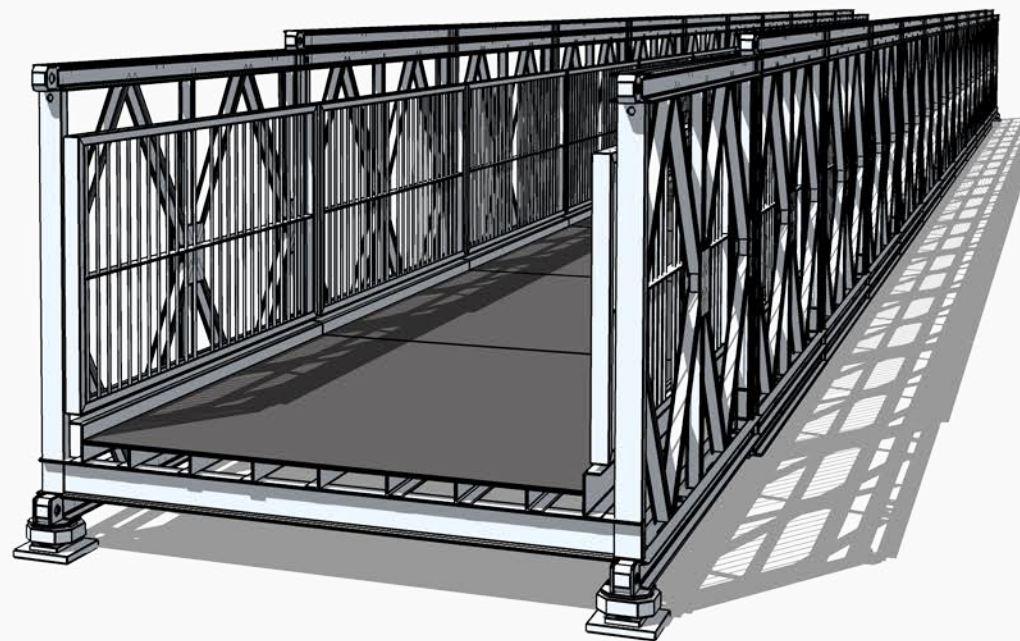

3D-Darstellung

	2,00m	2,50m	3,00m
verfügbare Deckbreiten			3,00m 6,00m 9,00m 12,00m 15,00m
verfügbare Spannweiten			18,00m 21,00m 24,00m 27,00m 30,00m 33,00m 36,00m 39,00m etc.
nachweisbar:	DIN-FB 101 DIN 1072 EuroCode		

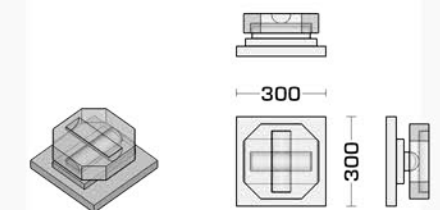

Detail: Lagerplatte

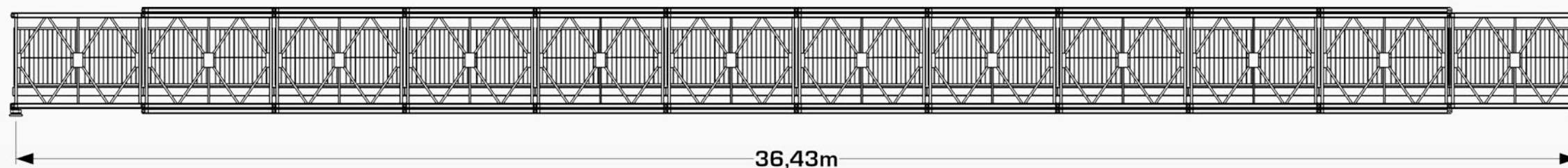

Seitenansicht

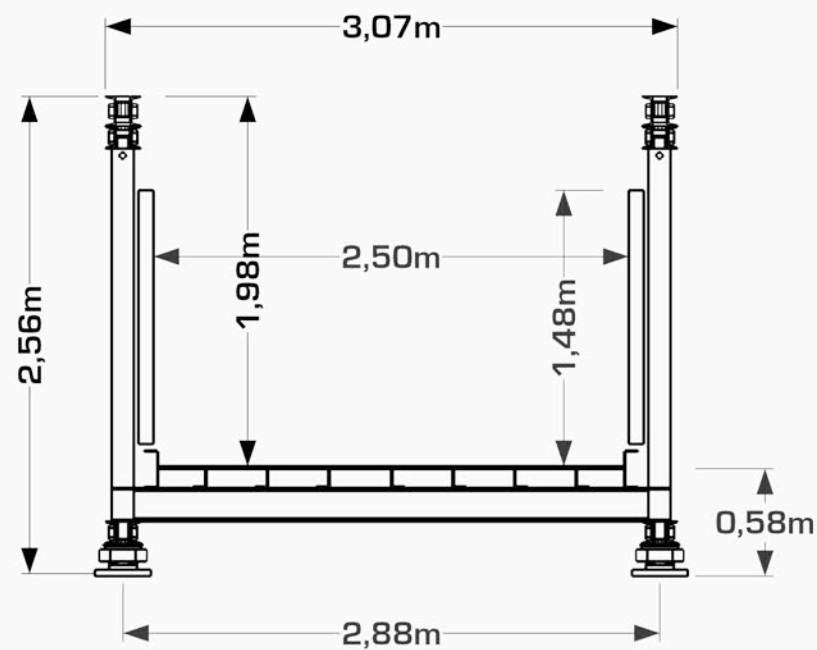

Vorderansicht

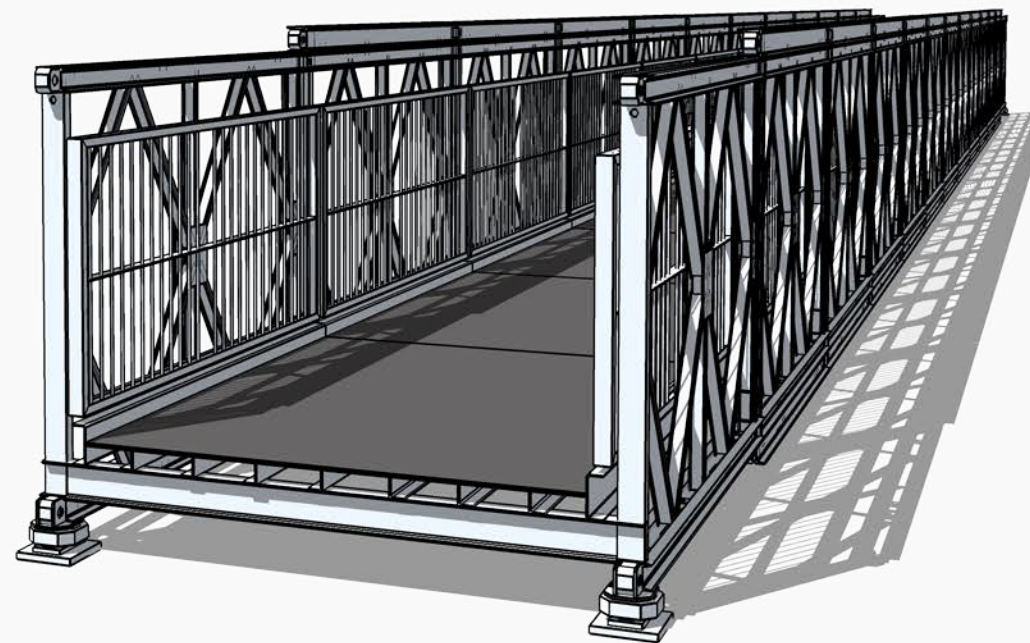

3D-Darstellung

	2,00m	2,50m	3,00m
verfügbare Deckbreiten	2,00m, 2,50m und 3,00m		
verfügbare Spannweiten	3,00m bis 60,00m freispannend		
nachweisbar:	DIN-FB 101 DIN 1072 EuroCode		
			3,00m 6,00m 9,00m 12,00m 15,00m 18,00m 21,00m 24,00m 27,00m 30,00m 33,00m ... 39,00m etc.

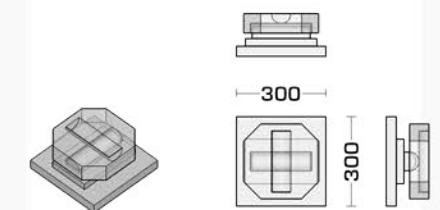

Detail: Lagerplatte

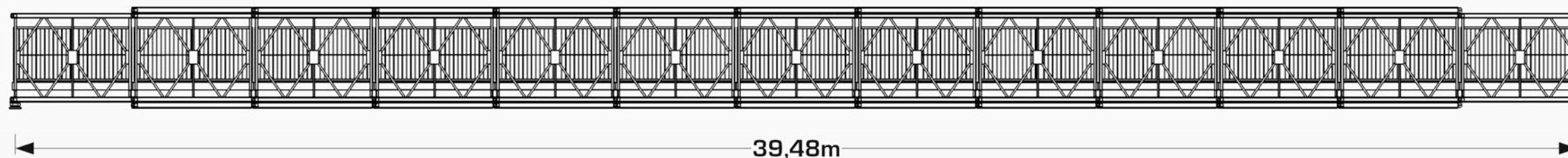

Seitenansicht

JPB ped - 42,00m x 2,50m SDR

Fußgängerbrückensystem Typ JPB ped

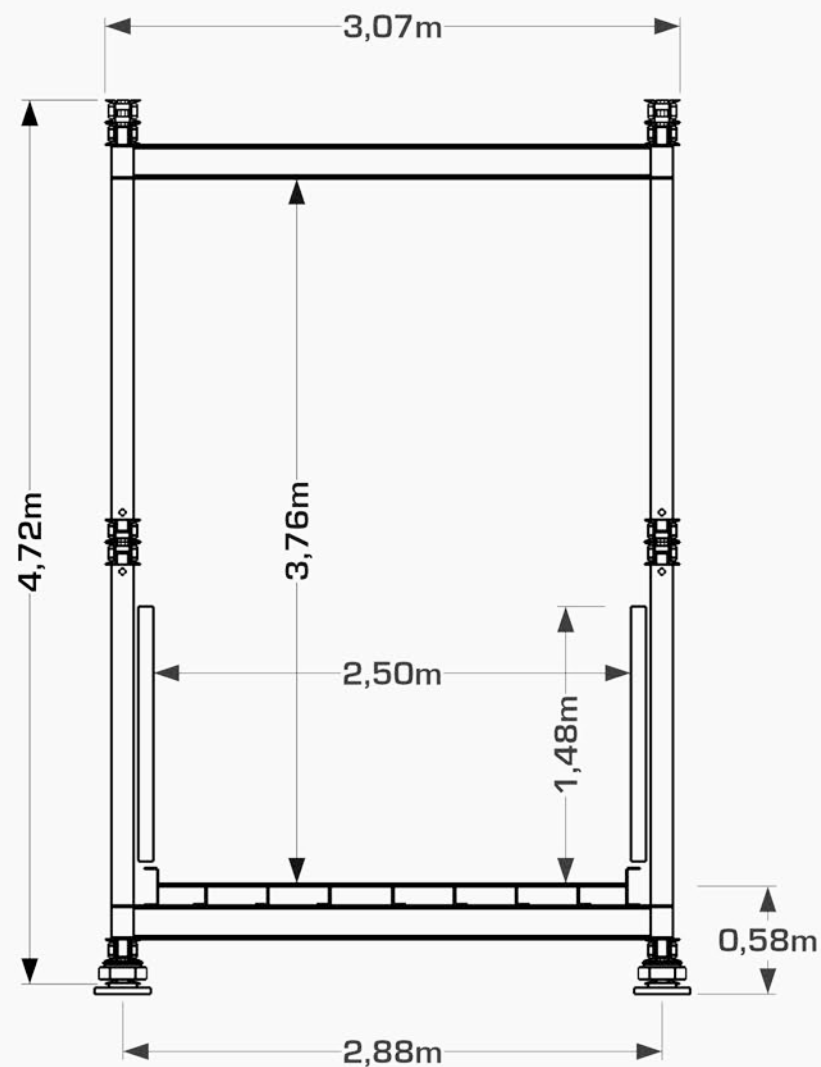

Vorderansicht

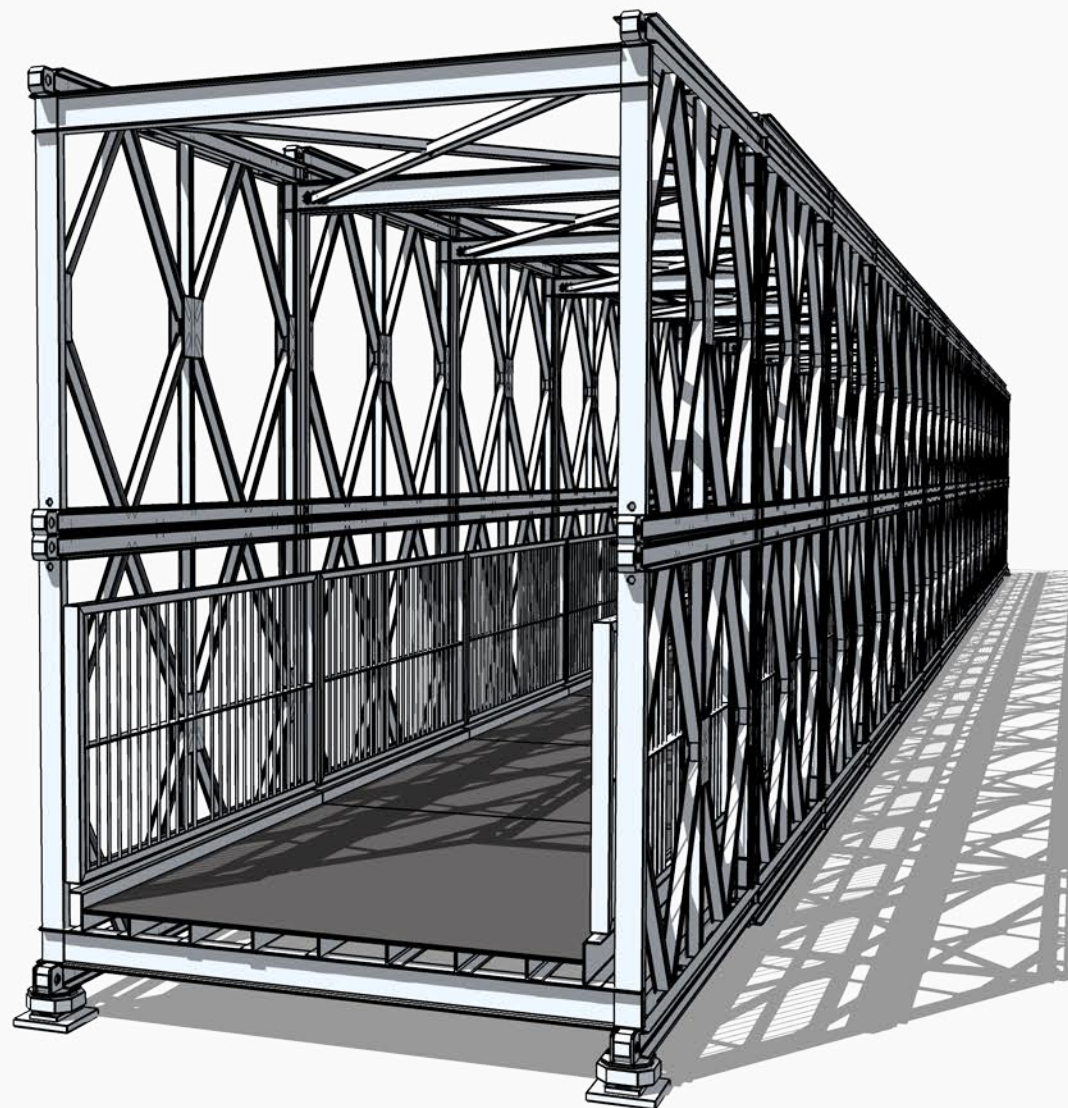

3D-Darstellung

	2,00m	2,50m	3,00m
verfügbare Deckbreiten			3,00m 6,00m 9,00m 12,00m 15,00m
verfügbare Spannweiten			18,00m 21,00m 24,00m 27,00m 30,00m 33,00m ... 42,00m etc.
nachweisbar:	DIN-FB 101 DIN 1072 EuroCode		

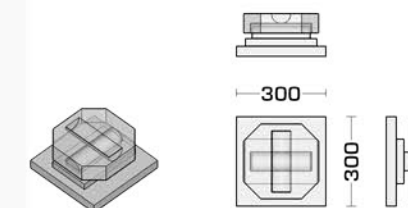

Detail: Lagerplatte

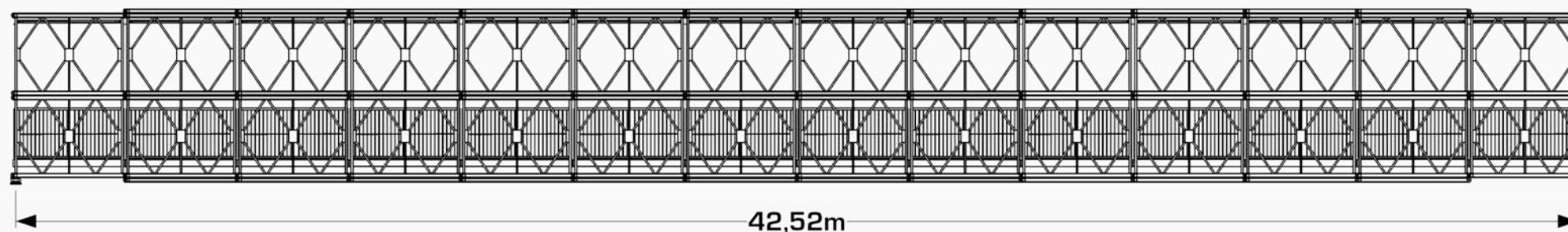

Seitenansicht

BRÜCKEN | PONTONS | RORO'S
vermietung & verkauf

Janson Bridging GmbH

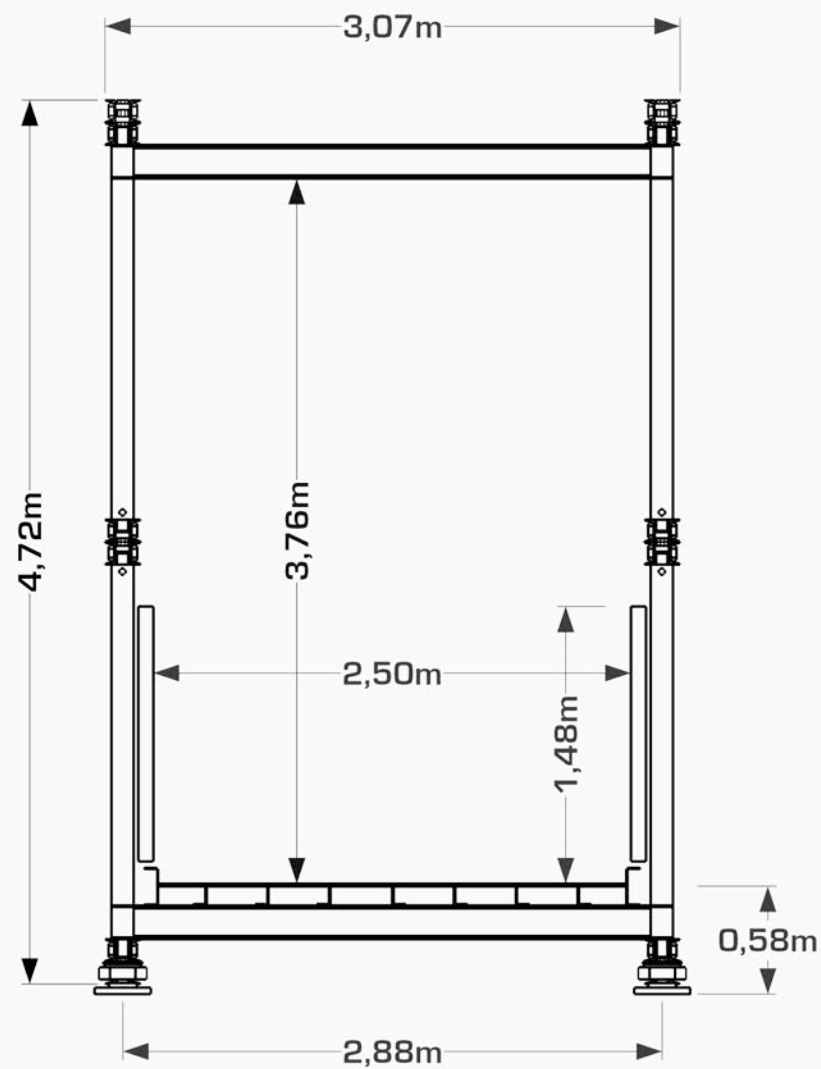

Vorderansicht

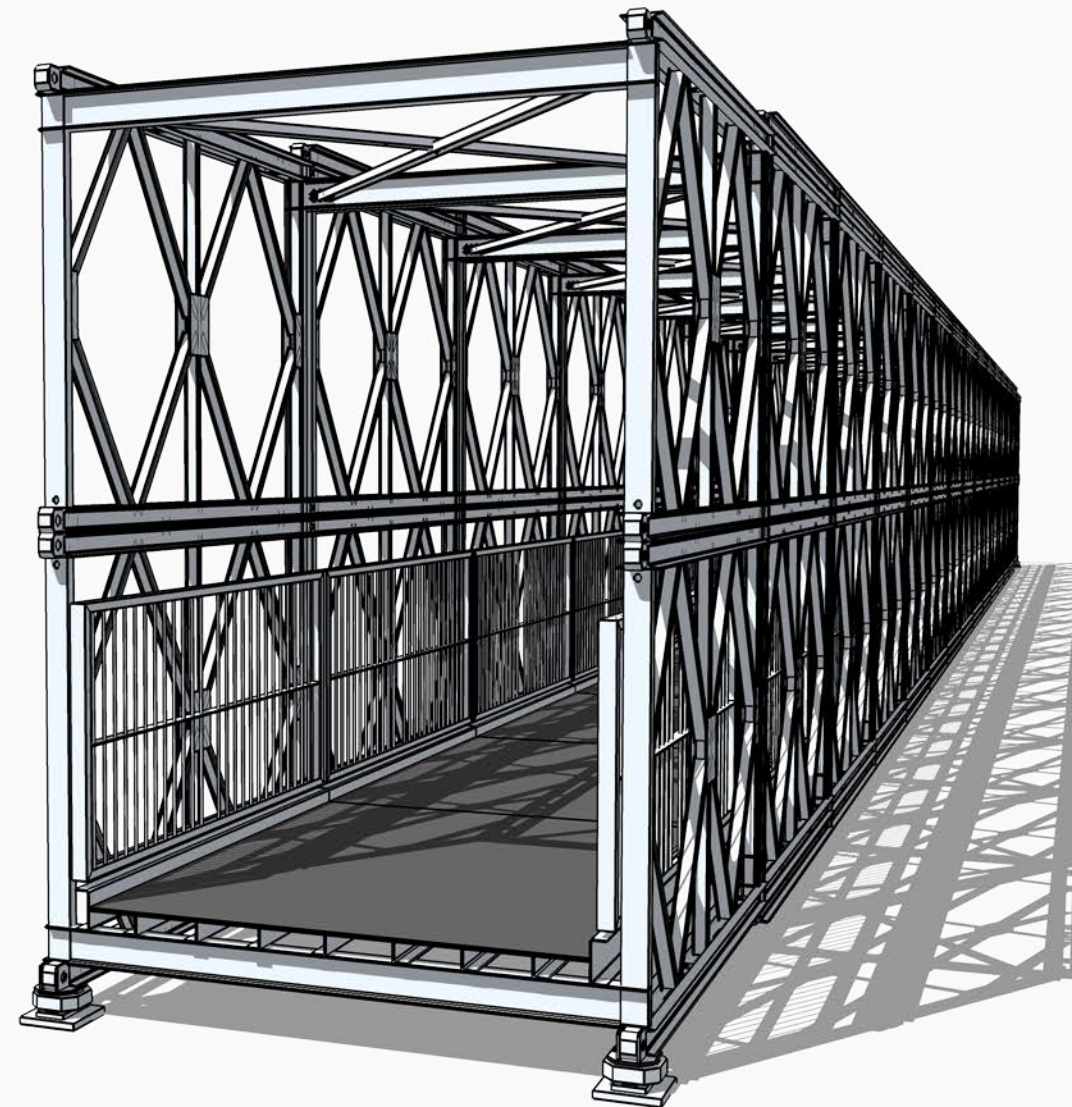

3D-Darstellung

	2,00m	2,50m	3,00m
verfügbare Deckbreiten			3,00m 6,00m 9,00m 12,00m 15,00m
verfügbare Spannweiten			18,00m 21,00m 24,00m 27,00m 30,00m 33,00m ... 45,00m etc.
nachweisbar:	DIN-FB 101 DIN 1072 EuroCode		

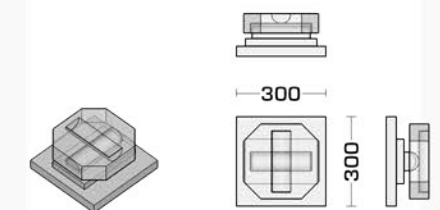

Detail: Lagerplatte

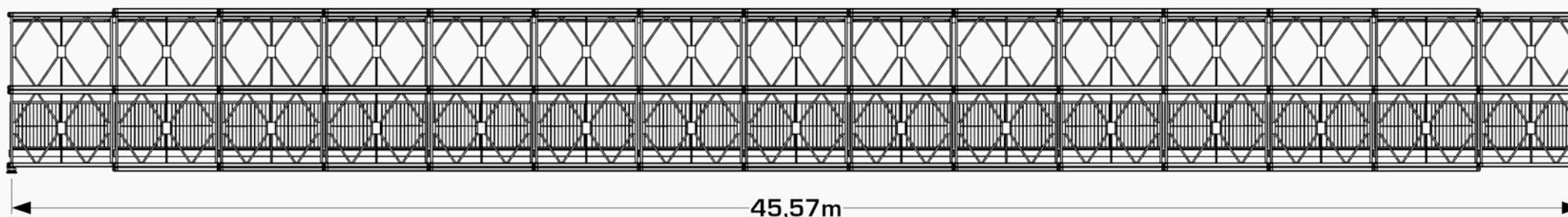

Seitenansicht

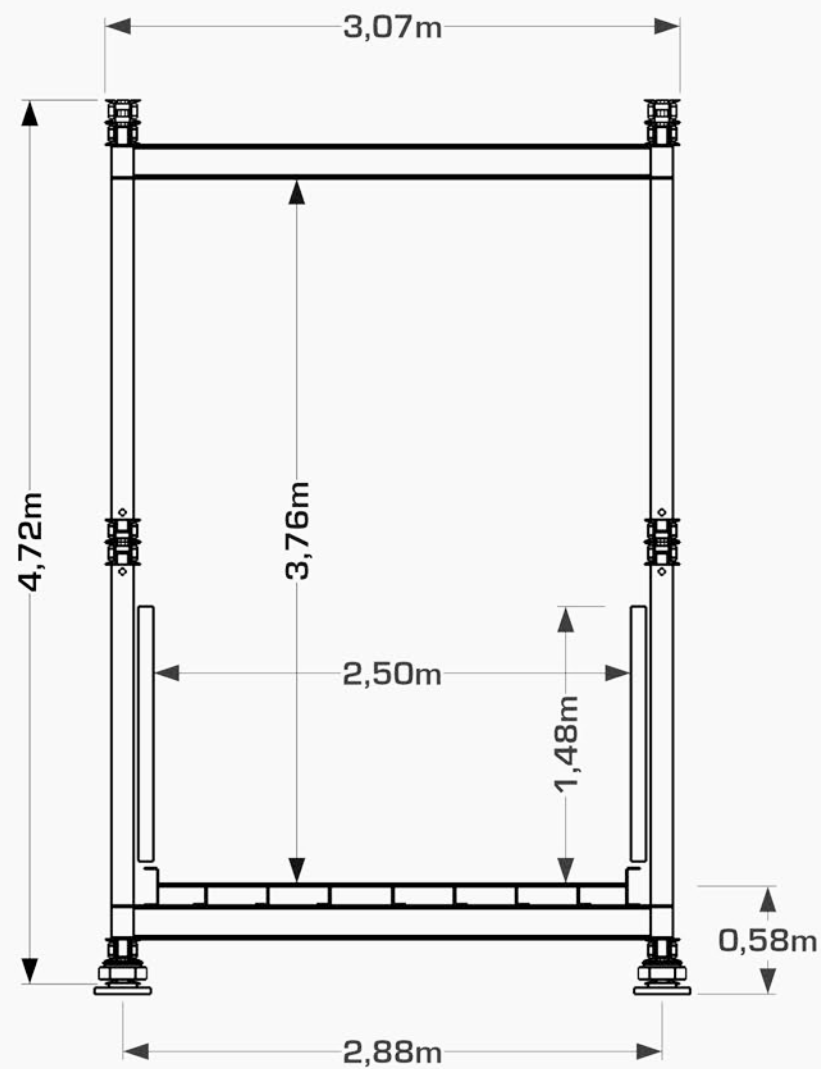

Vorderansicht

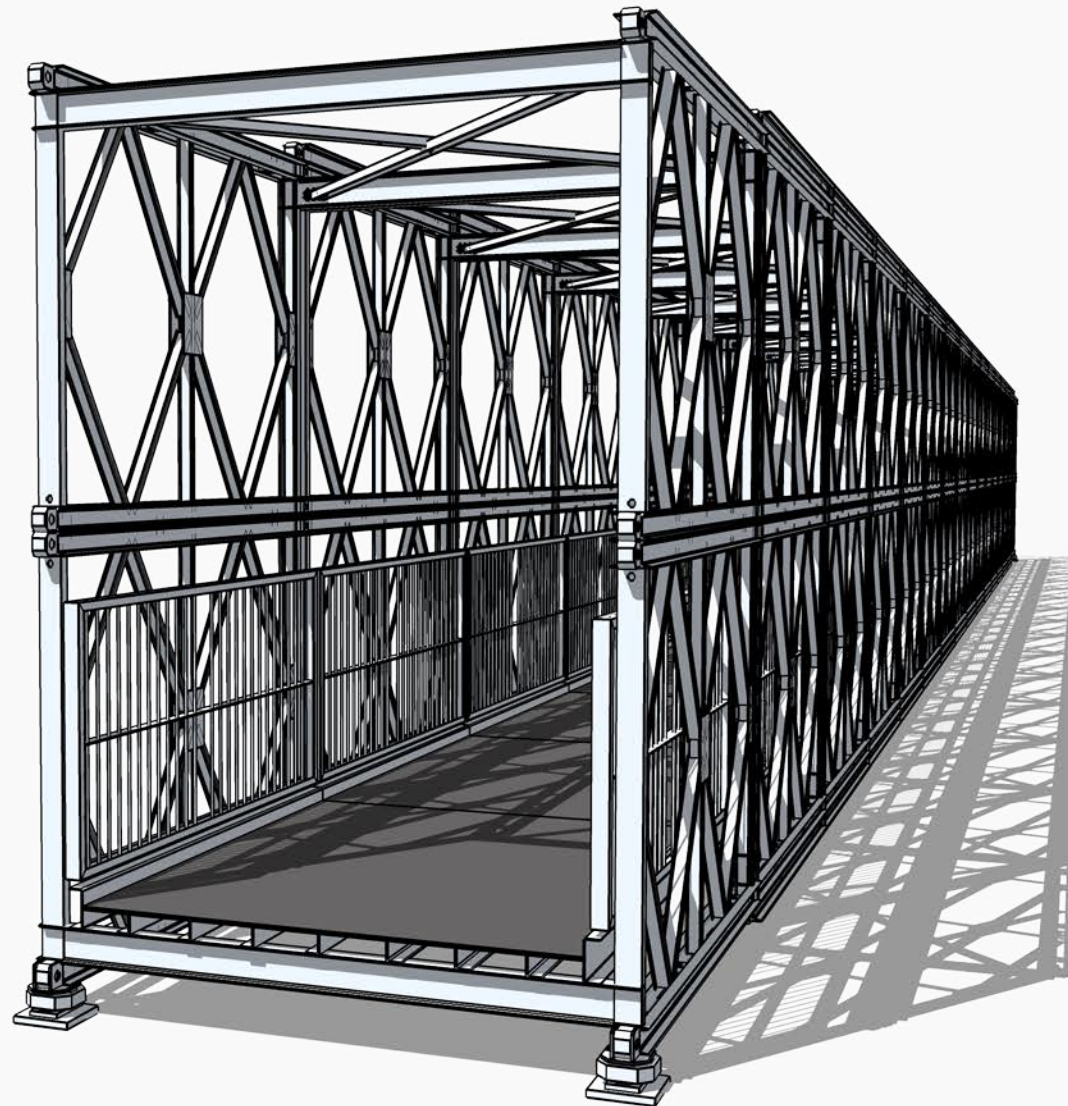

3D-Darstellung

	2,00m	2,50m	3,00m
verfügbare Deckbreiten			3,00m 6,00m 9,00m 12,00m 15,00m
verfügbare Spannweiten			18,00m 21,00m 24,00m 27,00m 30,00m 33,00m ... 48,00m etc.
nachweisbar:	DIN-FB 101 DIN 1072 EuroCode		

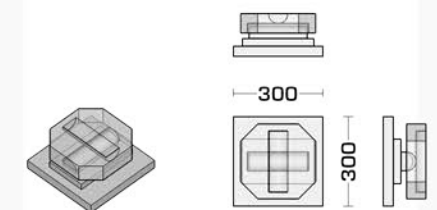

Detail: Lagerplatte

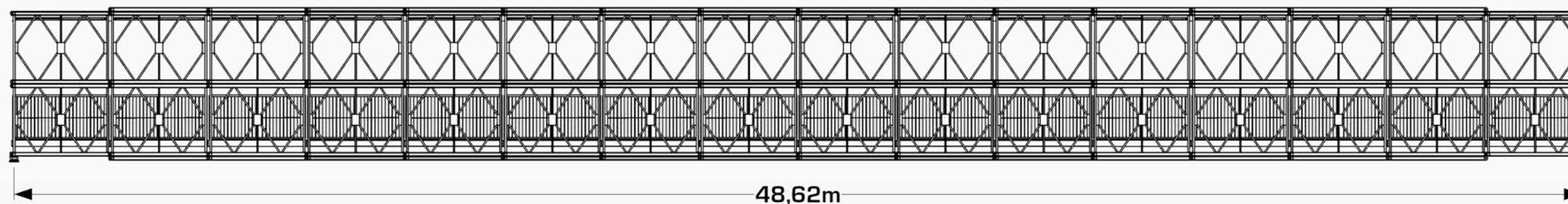

Seitenansicht

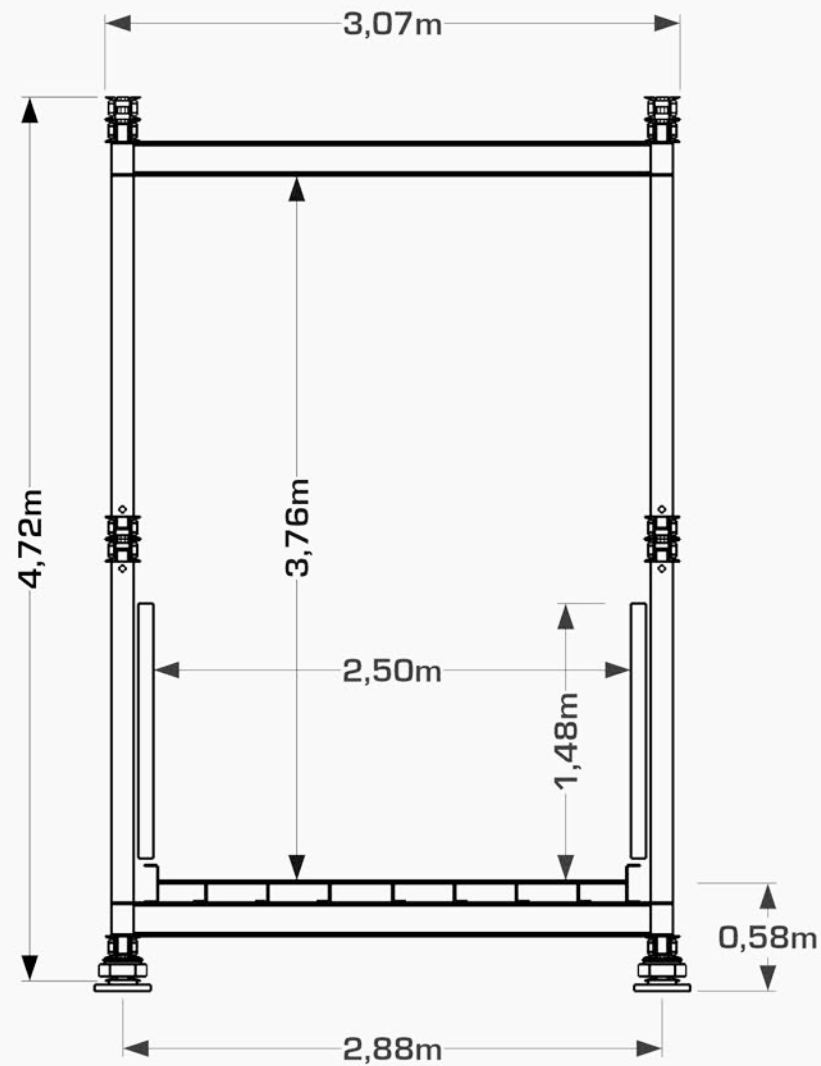

Vorderansicht

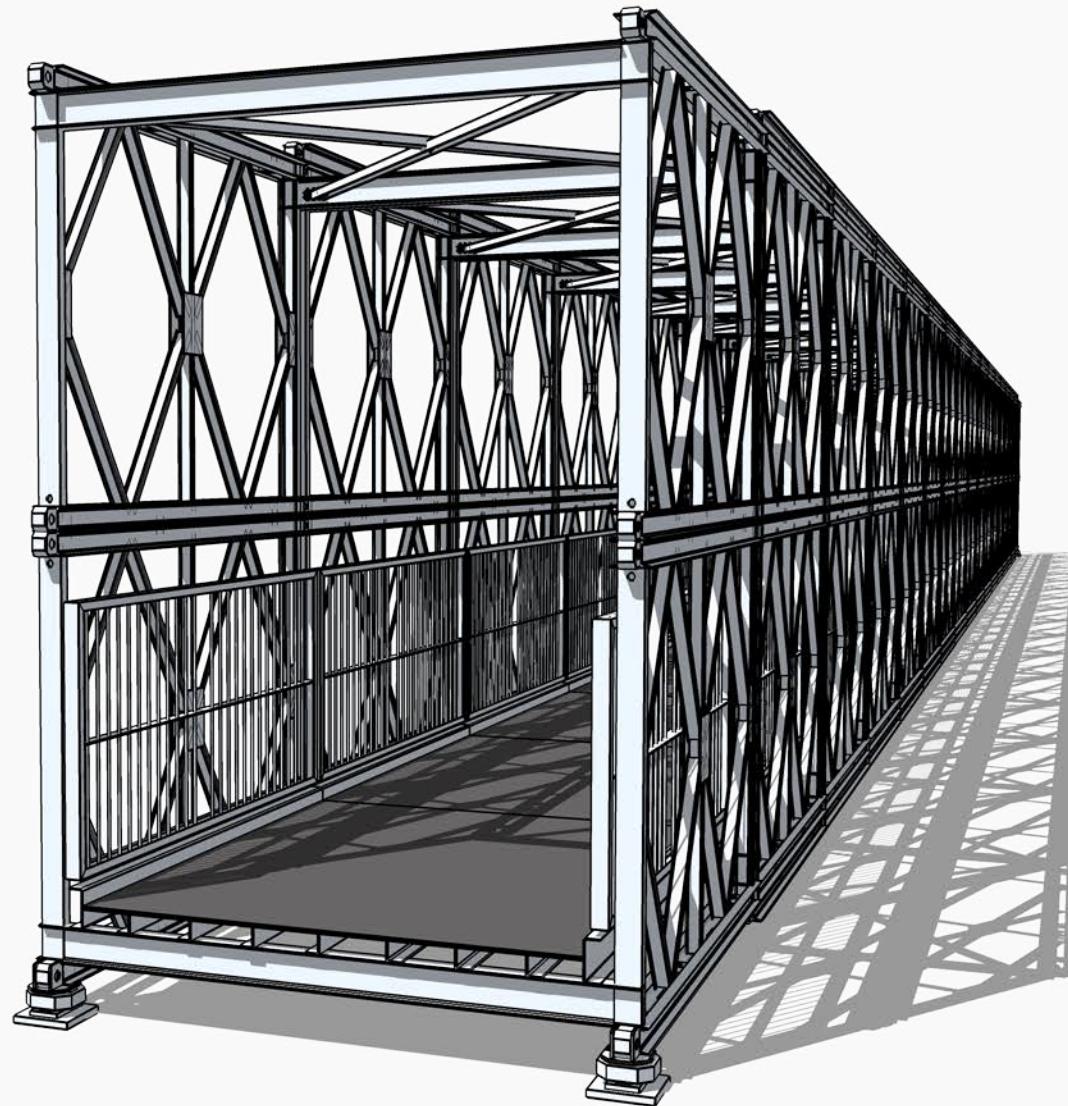

3D-Darstellung

	2,00m	2,50m	3,00m	
verfügbare Deckbreiten				3,00m 6,00m 9,00m 12,00m 15,00m
verfügbare Spannweiten				18,00m 21,00m 24,00m 27,00m 30,00m 33,00m ... 51,00m etc.
nachweisbar:	DIN-FB 101 DIN 1072 EuroCode			

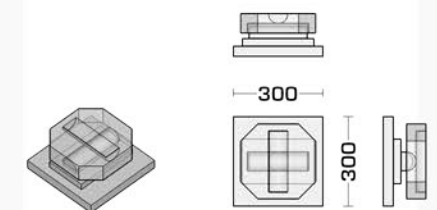

Detail: Lagerplatte

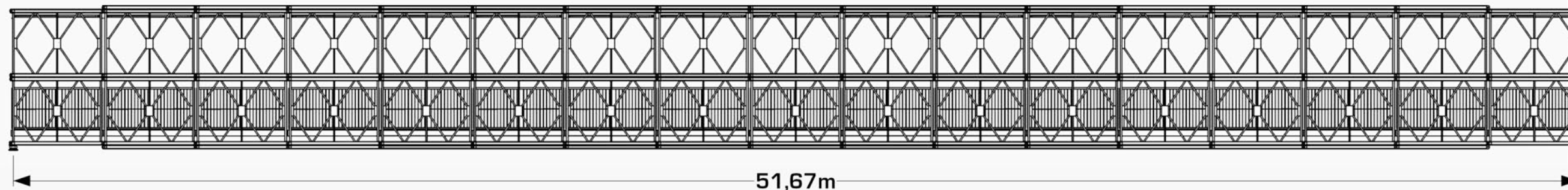

Seitenansicht

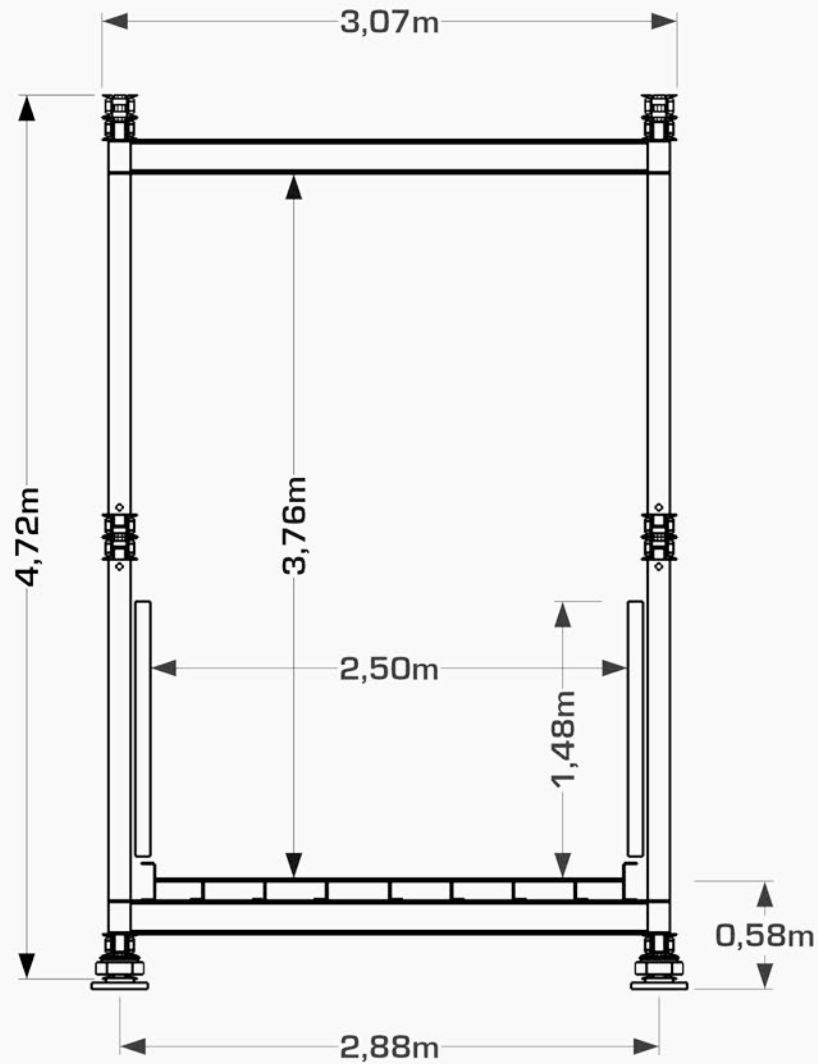

Vorderansicht

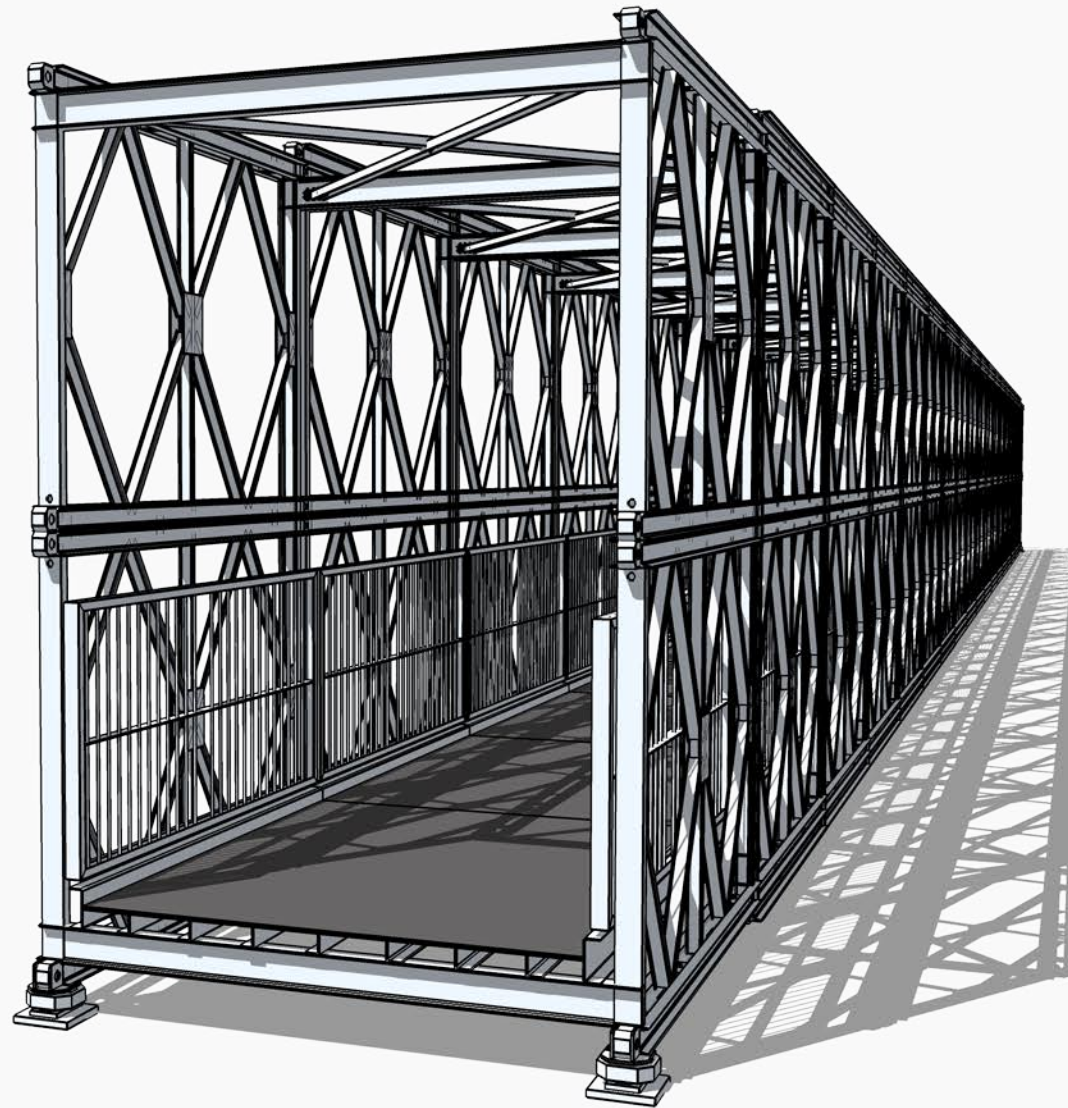

3D-Darstellung

	2,00m	2,50m	3,00m
verfügbare Deckbreiten	2,00m, 2,50m und 3,00m		
verfügbare Spannweiten	3,00m bis 60,00m freispannend		
nachweisbar:	DIN-FB 101 DIN 1072 EuroCode		
			3,00m 6,00m 9,00m 12,00m 15,00m 18,00m 21,00m 24,00m 27,00m 30,00m 33,00m ... 54,00m etc.

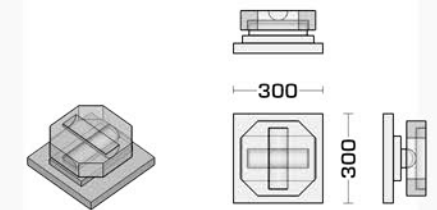

Detail: Lagerplatte

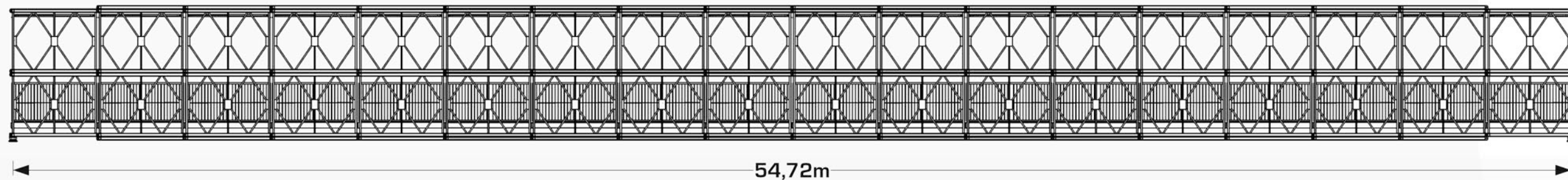

Seitenansicht

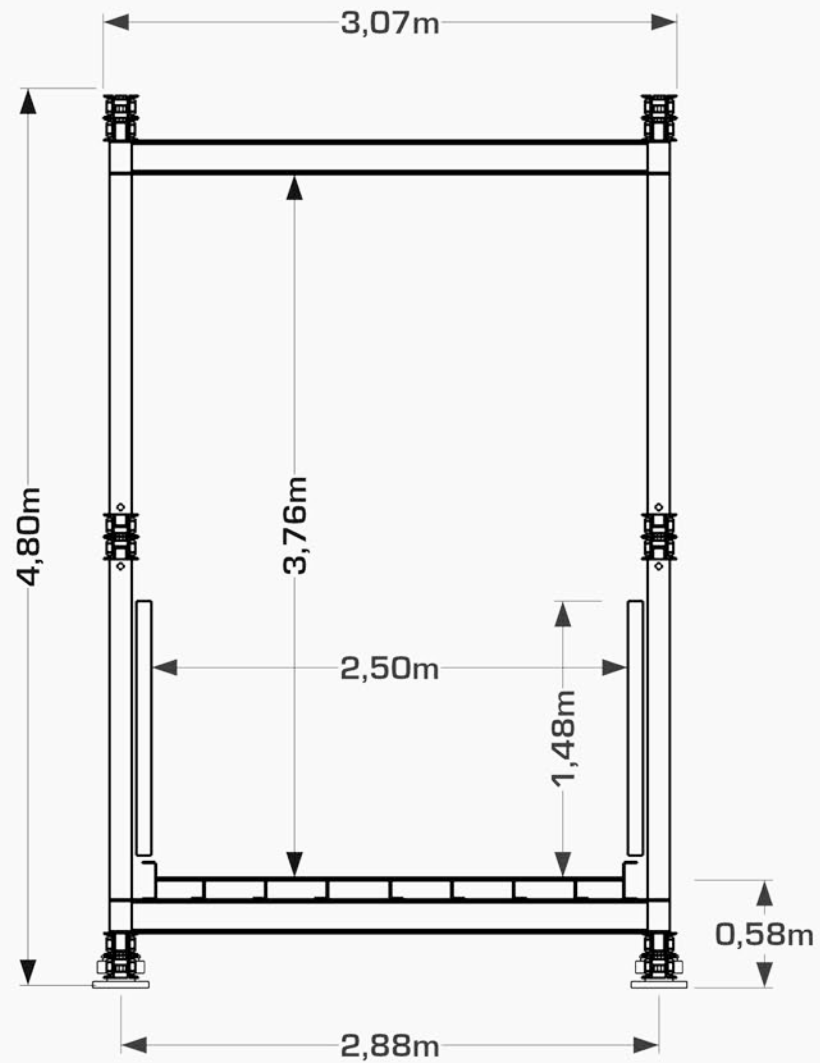

Vorderansicht

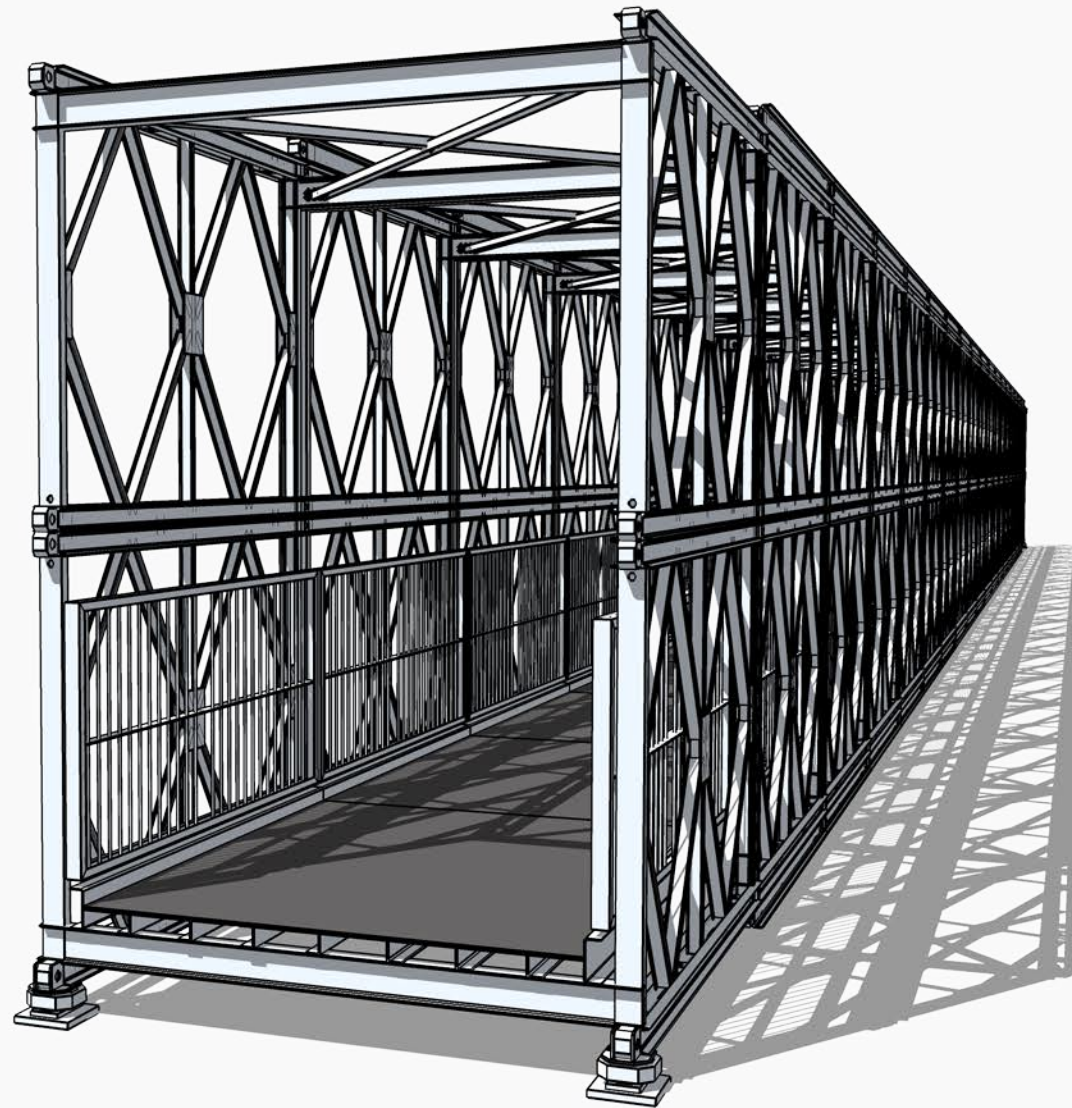

3D-Darstellung

	2,00m	2,50m	3,00m
verfügbare Deckbreiten			3,00m 6,00m 9,00m 12,00m 15,00m
verfügbare Spannweiten			18,00m 21,00m 24,00m 27,00m 30,00m 33,00m ... 57,00m etc.
nachweisbar:	DIN-FB 101 DIN 1072 EuroCode		

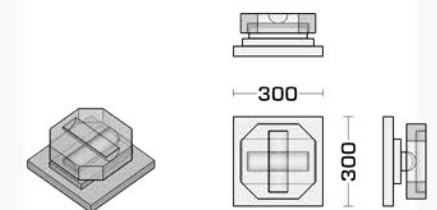

Detail: Lagerplatte

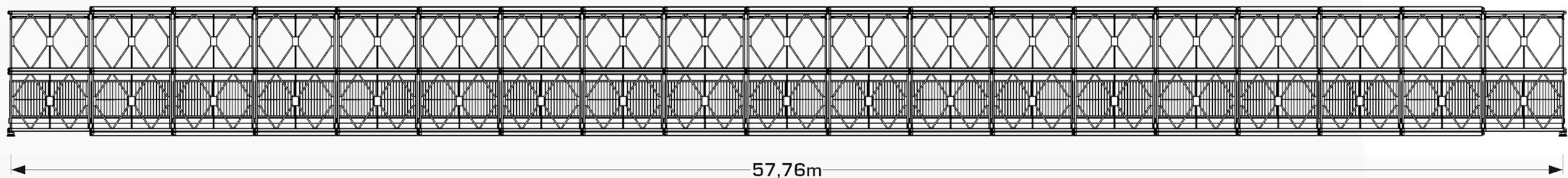

Seitenansicht